

Data Sheet

(規格書)

產品名稱 (Product)	<u>Bluetooth Low Energy Module</u>
解決方案 (Solution)	<u>Nordic nRF54L15 / nRF54L10 / nRF54L05</u> <u>QFN Package</u>
產品型號 (Model No.)	<u>AN54LQ-15 / AN54LQ-10 / AN54LQ-05</u> <u>(Chip Antenna)</u>
產品料號 (Part No.)	<u>See 4.3 Order code</u>

Model	Working distance (in Meters)			Operating Temperature
	125 Kbps	1 Mbps	2 Mbps	
AN54LQ-15 / 10 / 05	over 750	over 400	over 300	-40 ~ 105°C
AN54LQ-P15 / P10 / P05	over 450	up to 250	up to 200	-40 ~ 105°C
AN54LQ-U15 / U10 / U05	over 750	up to 400	up to 300	-40 ~ 85°C

Working range is tested in open space

Index

1. Overall introduction	4
1.1. Application	4
1.2. Features	5
2. Product dimension	6
2.1. PCB dimensions & pin Indication	6
2.2. Recommended layout of solder pad	7
2.3. RF layout suggestion (AKA, antenna keep-out area)	9
2.4. Footprint & design guide	10
2.5. Pin assignment	11
3. Main chip solution	16
4. Shipment packaging information	17
4.1. Marking on metal shield	20
4.2. Packaging Info	20
4.2.1. Tray Packaging	20
4.2.2. Reel packaging	21
4.3. Order code	22
5. Specification	23
5.1. Recommended operating conditions	23
5.2. Radio specifications	23
5.2.1. General radio characteristics	23
5.2.2. Radio current consumption (Transmitter)	24
5.2.3. Radio current consumption (Receiver)	24
5.2.4. Transmitter specification	25
5.2.5. Receiver operation	25
5.2.6. RX selectivity	26
5.2.7. RX intermodulation	27
5.2.8. Radio timing parameters	28
5.2.9. RSSI specifications	28
5.3. Absolute maximum ratings	29
6. Block Diagram	31
7. Reference circuit	32
8. Certification	33
8.1. Declaration ID for Bluetooth	33
8.2. FCC Certificate (USA)	34

8.3.	TELEC Certificate (Japan).....	37
8.4.	NCC Certificate (Taiwan)	38
8.5.	CE (EU) & RCM (Australia & New Zealand) test report.....	41
8.6.	IC Certificate (Canada).....	49
8.7.	SRRC Certificate (China).....	50
8.8.	KC Certificate (South Korea)	52
8.9.	WPC Certificate (India).....	53
8.10.	EU and UKCA Declarations of Conformity.....	55
8.11.	RoHS & REACH report.....	55
8.12.	End-product label	55
8.12.1.	FCC (USA).....	56
8.12.2.	TELEC (Japan)	56
8.12.3.	NCC (Taiwan).....	56
8.12.4.	IC (Canada)	57
8.13.	Compliance and Certification.....	58
8.13.1.	List of Applicable FCC Rules	58
8.13.2.	RF Exposure Considerations	58
8.13.3.	Antennas.....	59
8.13.4.	Information on Test Modes and AdditionalL Testing Requirements.....	59
8.13.5.	Additional Testing, Part 15 Subpart B Disclaimer	60
8.13.6.	Note EMI Considerations	60
8.13.7.	How to Make Changes.....	60
9.	Notes and Cautions.....	61
10.	Useful links	62
	Full list of Raytac’s Wi-Fi modules.....	63
	Full list of Raytac’s Bluetooth modules.....	64
	Release Note.....	69

1. Overall introduction

Raytac's AN54LQ family uses a Bluetooth® 6.0 stack (Bluetooth low energy or BLE) modules designed based on **Nordic nRF54L15, nRF54L10, and nRF54L05 SoC solution**, which incorporates: **GPIO, QSPI (emulated), SPI, UART, I2C, I2S, PDM, PWM, ADC and NFC** interfaces for connecting peripherals and sensors.

Product Character:

1. MCU (Microcontroller Unit) featuring a 128 MHz Arm Cortex-M33 processor.
2. **AN54LQ-15** Embedded **1524 KB** NVM and up to **256 KB** RAM.
AN54LQ-10 Embedded **1012 KB** NVM and up to **192 KB** RAM.
AN54LQ-05 Embedded **500 KB** NVM and up to **96 KB** RAM.
3. An integrated RISC-V coprocessor.
4. The multiprotocol 2.4 GHz radio modes are supported based on customer preference.
5. Compact size with **(L) 13.7 x (W) 9.5 x (H) 1.8mm**
6. Wide supply voltage range **1.7V to 3.6V**.
7. Operation temperature from **-40°C to 105°C**.
8. Up to **31** GPIOs.

1.1. Application

- IoT
 - Smart home sensors and actuators
 - Industrial sensors and actuators
 - Gateways and hubs
- Advanced computer peripherals and I/O devices
 - Keyboard
 - Mouse
 - Stylus
- Interactive entertainment devices
 - Remote controls
 - Gaming controllers
- Safety and security
 - Access control
 - Asset tracking
- Wearable health and fitness monitoring
- Lighting control

1.2. Features

- Multi-protocol 2.4GHz radio
- 128MHz Arm Cortex-M33 with Thumb-2 (16/32-bit instruction set)
- 1524KB flash programmed memory and 256KB RAM
- 128-bit AES / ECB / CCM / AAR co-processor
- Up to +7dBm configurable output power
- RSSI (1dB resolution)

Peripherals

- 128 MHz RISC-V coprocessor which is a fast, lightweight peripheral processor (FLPR)
- Timer counter
 - 7 x 32-bit
 - 2 x 24-bit RTC
- Fully featured serial interface with EasyDMA support including:
 - One high-speed SPI up to 32 MHz, four up to 8 MHz
 - One high-speed UART up to 4 Mbps, four up to 1 Mbps
 - I2C up to 400 kHz
- Three pulse width modulator (PWM) units with EasyDMA
- I2S two channel Inter-IC sound interface
- ADC with up to eight programmable gain channels.
- Pulse density modulation (PDM) interface
- Near field communication (NFC)
- Quadrature decoders(QDEC)
- Temperature sensor

2. Product dimension

2.1. PCB dimensions & pin Indication

• AN54LQ-15 / AN54LQ-10 / AN54LQ-05

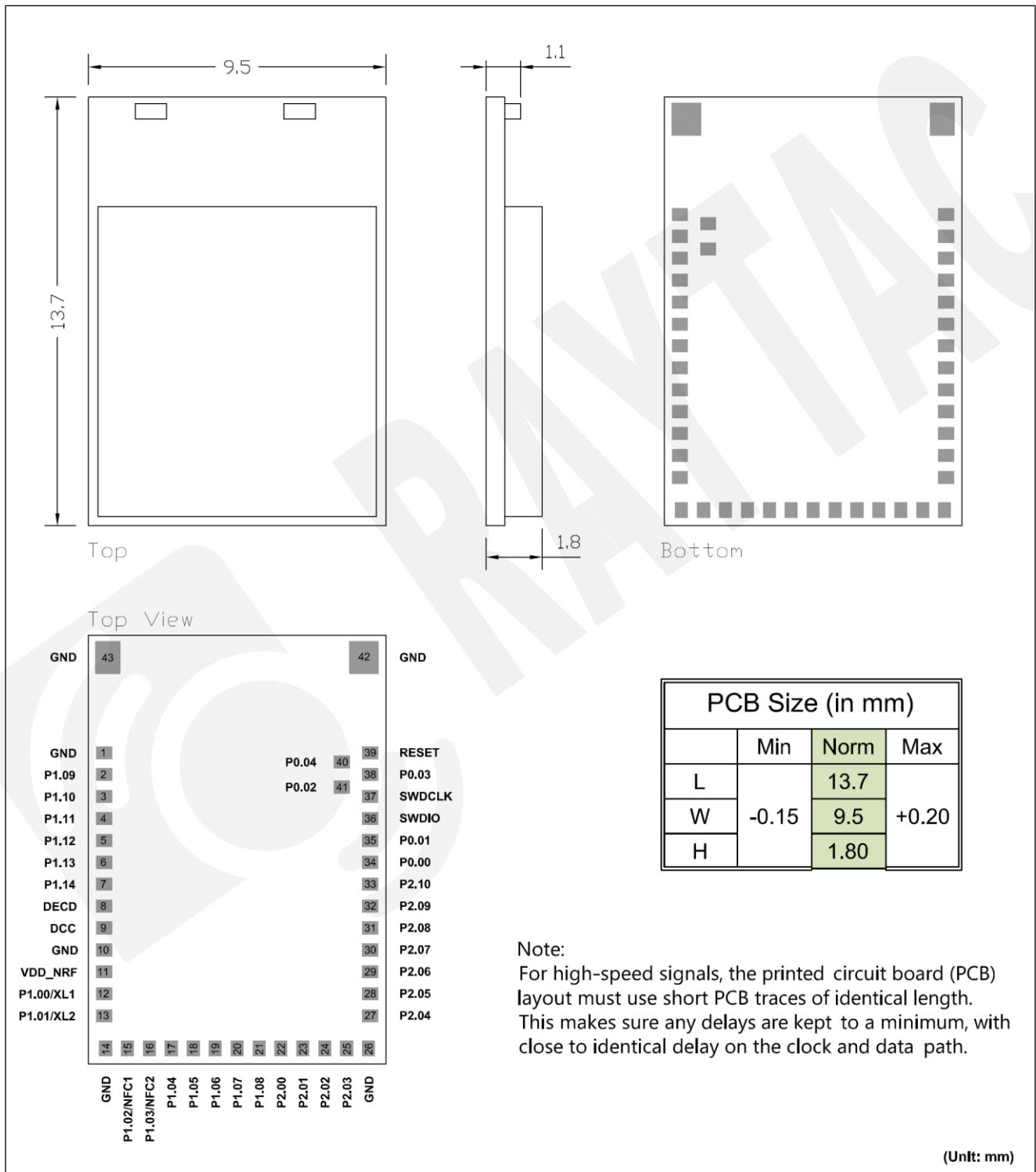

2.2. Recommended layout of solder pad

Graphs are all in Top View, Unit in mm.

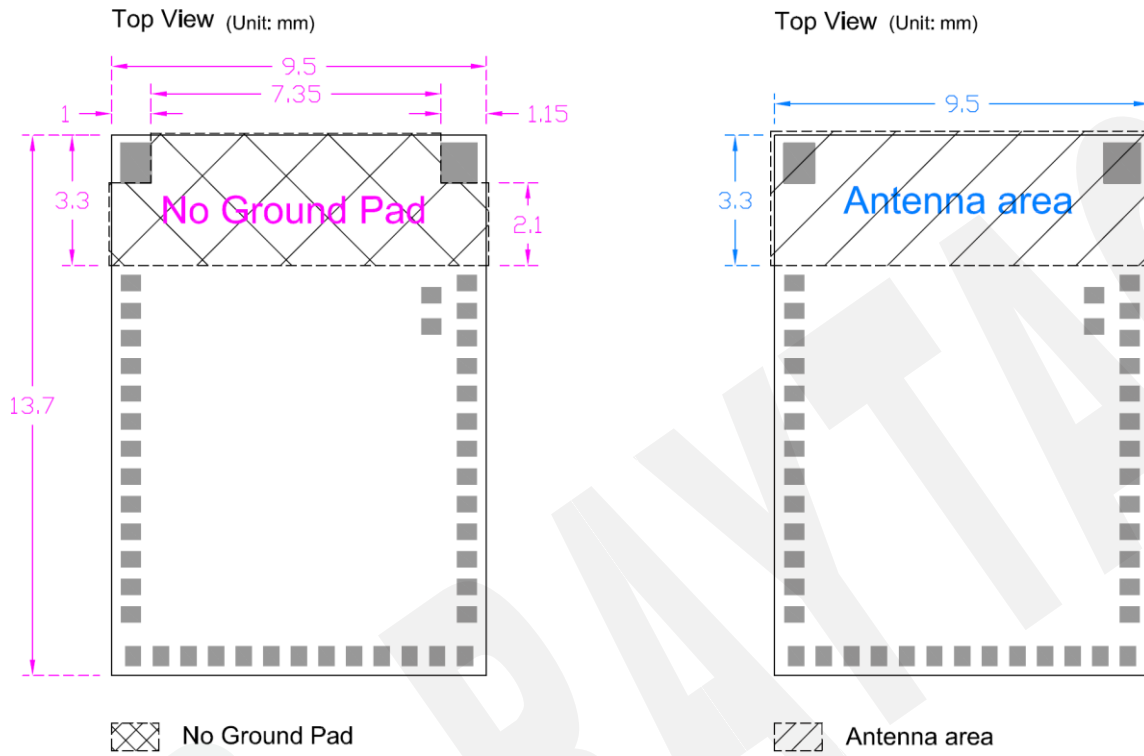

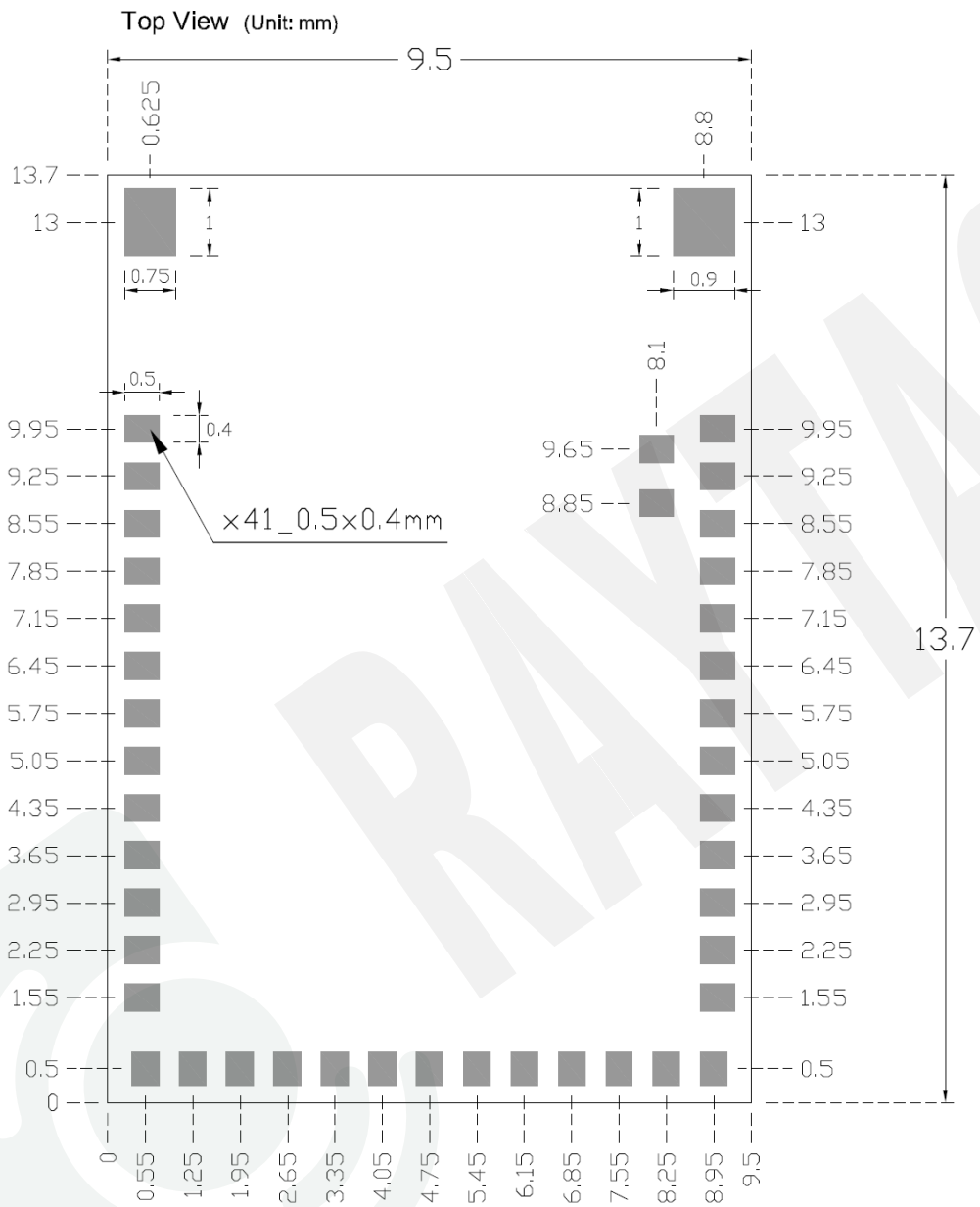

2.3. RF layout suggestion (AKA, antenna keep-out area)

Please ensure that no ground pad overlaps the “No Ground-Pad Area”, as shown in the images below. This is important to maintain antenna performance and to prevent potential short circuits within the module.

You are welcome to send us your design files for review at sales@raytac.com or to your Raytac contact with email subject titled: “Layout Review – Raytac Model No. – Your company name”.

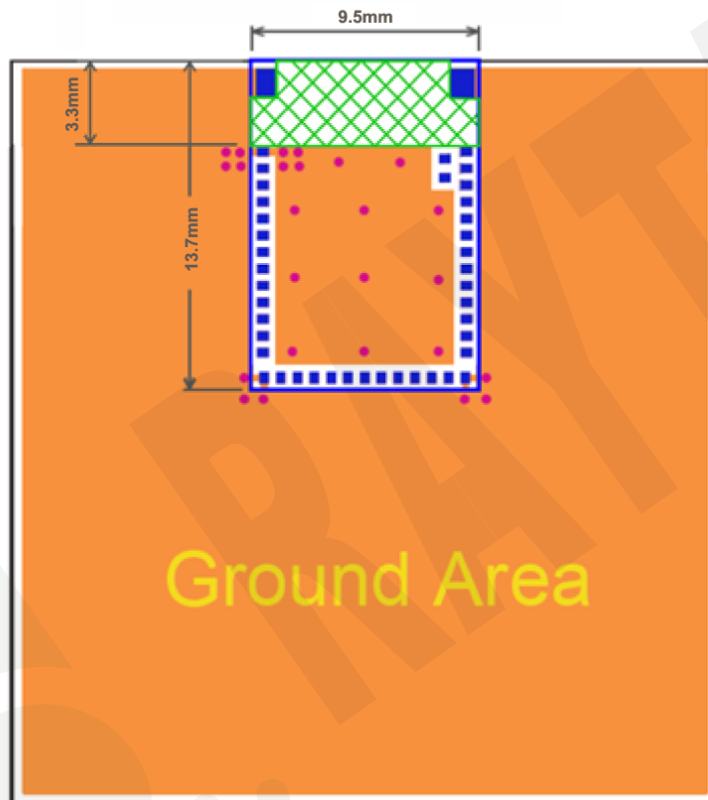

Top View

 No Ground Pad Area

Please add vid holes in GROUND area as may as possible, especially around the four corners.

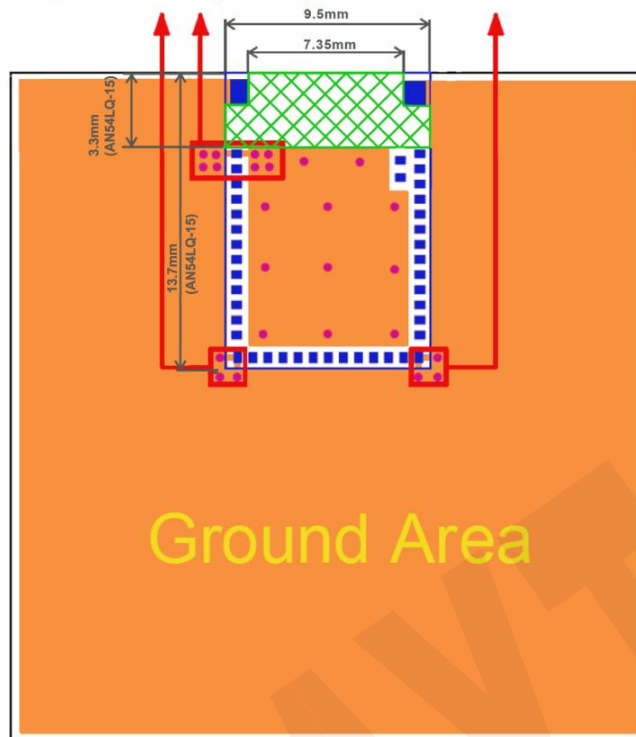

Top View



Perspective View

 No Ground Pad Area

2.4. Footprint & design guide

Please visit "[Support](#)" page of our website to download. The package includes footprint, 2D/3D drawing, and reflow graph/solder profile.

2.5. Pin assignment

Pin No.	Name	Pin function	Description
(1)	GND	Ground	The pad must be connected to a solid ground plane
	P1.09	Digital I/O	General-purpose I/O
(2)	ASO [2]	Digital I/O	TAMPC active shield 2 output
	RADIO [0]	Digital I/O	RADIO DFEGPIO
	P1.10	Digital I/O	General-purpose I/O
(3)	ASI [2]	Digital I/O	TAMPC active shield 2 input
	RADIO [1]	Digital I/O	RADIO DFEGPIO
	P1.11	Digital I/O	General-purpose I/O Clock pin
(4)	ASO [3]	Digital I/O	TAMPC active shield 3 output
	RADIO [2]	Digital I/O	RADIO DFEGPIO
	AIN4	Analog input	Analog input
	P1.12	Digital I/O	General-purpose I/O Clock pin
(5)	ASI [3]	Digital I/O	TAMPC active shield 3 input
	RADIO [3]	Digital I/O	RADIO DFEGPIO
	AIN5	Analog input	Analog input
	P1.13	Digital I/O	General-purpose I/O
(6)	RADIO [4]	Digital I/O	RADIO DFEGPIO
	AIN6	Analog input	Analog input
	P1.14	Digital I/O	General-purpose I/O
(7)	RADIO [5]	Digital I/O	RADIO DFEGPIO
	AIN7	Analog input	Analog input
(8)	DECD	Power	0.9 V regulator supply decoupling
(9)	DCC	Power	DC/DC regulator output
(10)	GND	Ground	The pad must be connected to a solid ground plane
(11)	VDD_NRF	Power	Power-supply pin
(12)	P1.00	Digital I/O	General-purpose I/O
	XL1	Analog input	Connection for 32.768khz crystal
(13)	P1.01	Digital I/O	General-purpose I/O
	XL2	Analog input	Connection for 32.768khz crystal

Pin No.	Name	Pin function	Description
(14)	GND	Ground	The pad must be connected to a solid ground plane
(15)	P1.02	Digital I/O	General-purpose I/O
	NFC1	NFC input	NFC antenna connection
(16)	P1.03	Digital I/O	General-purpose I/O Clock pin
	NFC2	NFC input	NFC antenna connection
(17)	P1.04	Digital I/O	General-purpose I/O Clock pin
	ASO [0]	Digital I/O	TAMPC active shield 0 output
	AIN0	Analog input	Analog input
(18)	P1.05	Digital I/O	General-purpose I/O
	ASI [0]	Digital I/O	TAMPC active shield 0 input
	RADIO [6]	Digital I/O	RADIO DFEGPIO
	AIN1	Analog input	Analog input
(19)	P1.06	Digital I/O	General-purpose I/O
	ASO [1]	Digital I/O	TAMPC active shield 1 output
	AIN2	Analog input	Analog input
(20)	P1.07	Digital I/O	General-purpose I/O
	ASI [1]	Digital I/O	TAMPC active shield 1 input
	AIN3	Analog input	Analog input
(21)	P1.08	Digital I/O	General-purpose I/O
			GRTC CLKOUTFAST
			Clock pin
	EXTREF	Analog input	External reference for SAADC
(22)	P2.00	Digital I/O	General-purpose I/O
			SPIM DCX
			UARTE RXD
			FLPR.4
			QSPI D3

Pin No.	Name	Pin function	Description
(23)	P2.01	Digital I/O	General-purpose I/O
			SPIM SCK
			SPIS SCK
			FLPR.0
			QSPI SCK
			Clock pin
(24)	P2.02	Digital I/O	General-purpose I/O
			SPIM SDO
			SPIS SDO
			UARTE TXD
			FLPR.1
			QSPI D0
(25)	P2.03	Digital I/O	Serial wire output (SWO)
			General-purpose I/O
			FLPR.3
(26)	GND	Ground	QSPI D2
			The pad must be connected to a solid ground plane
(27)	P2.04	Digital I/O	General-purpose I/O
			SPIM SDI
			SPIS SDI
			UARTE CTS
			FLPR.2
			QSPI D1
(28)	P2.05	Digital I/O	General-purpose I/O
			SPIM CS
			SPIS CS
			UARTE RTS
			FLPR.5
			QSPI CS

Pin No.	Name	Pin function	Description
(29)	P2.06	Digital I/O	General-purpose I/O
			FLPR.6
			SPIM SCK
			SPIS SCK
			Clock pin
	TRACECLK	Digital I/O	Trace clock
(30)	P2.07	Digital I/O	General-purpose I/O
			FLPR.7
			SPIM DCX
			UARTE RXD
			TRACEDATA [0]
	SWO		Serial wire output (SWO)
(31)	P2.08	Digital I/O	General-purpose I/O
			FLPR.8
			SPIM SDO
			SPIS SDO
			UARTE TXD
	TRACEDATA [1]	Digital I/O	Trace data
(32)	P2.09	Digital I/O	General-purpose I/O
			FLPR.9
			SPIM SDI
			SPIS SDI
			UARTE CTS
	TRACEDATA [2]	Digital I/O	Trace data
(33)	P2.10	Digital I/O	General-purpose I/O
			FLPR.10
			SPIM CS
			SPIS CS
			UARTE RTS
	TRACEDATA [3]	Digital I/O	Trace data
(34)	P0.00	Digital I/O	General-purpose digital I/O
(35)	P0.01	Digital I/O	General-purpose digital I/O

Pin No.	Name	Pin function	Description
(36)	SWDIO	Debug	Serial wire data. Bidirectional with standard-drive and on-chip pull-down.
(37)	SWDCLK	Debug	Serial wire clock. Input with on-chip pull-up.
(38)	P0.03	Digital I/O	General-purpose I/O GRTC PWM Clock pin
(39)	RESET	Reset	Pin reset with on-chip pull-up (low active)
(40)	P0.04	Digital I/O	General-purpose I/O GRTC CLKOUT32K Clock pin
(41)	P0.02	Digital I/O	General-purpose digital I/O
(42) (43)	GND	Ground	The pad must be connected to a solid ground plane (Only for AN54LQ-15 Model)

3. Main chip solution

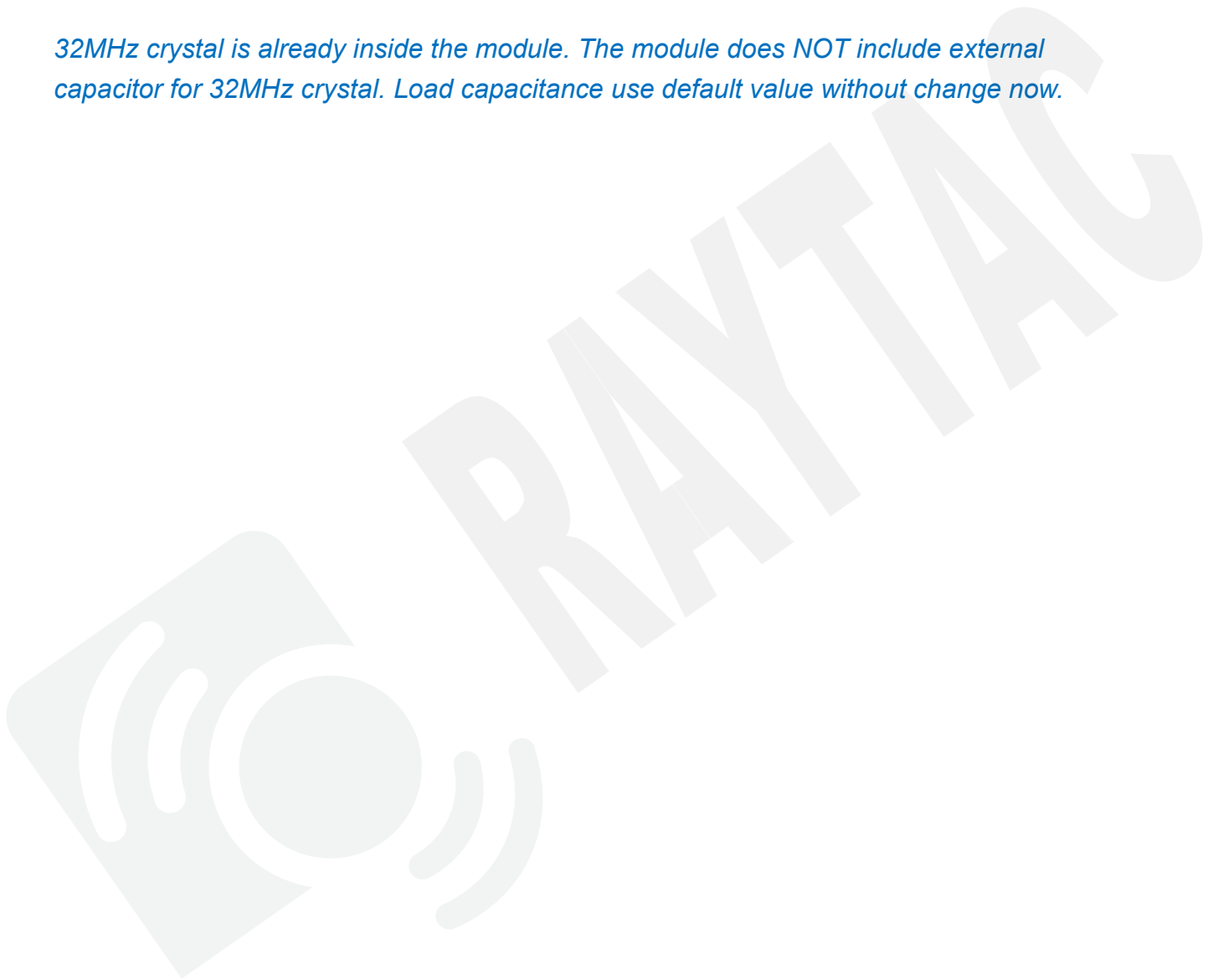

RF IC	Crystal Frequency
Nordic NRF54L15 / QFN	32MHz

32MHz crystal is already inside the module. The module does NOT include external capacitor for 32MHz crystal. Load capacitance use default value without change now.



4. Shipment packaging information

AN54LQ-15 Series

Model	Antenna	Photo
AN54LQ-15	Chip/Ceramic	
AN54LQ-P15	PCB/Printed	
AN54LQ-U15	U.FL/Connector	



- Unit weight of module:

AN54LQ-15 : 0.51 g (± 0.02 g) ; AN54LQ-P15 : 0.51 g (± 0.02 g) ; AN54LQ-U15 : 0.55 g (± 0.02 g) ;

- Packaging type: Tray or Tape & Reel.

	Tray	Tape & Reel
MPQ (Min. Package Q'ty)	88 pcs per tray	1,500 pcs per reel
Carton Contents (per carton)	1,760 pcs	1,500 pcs
Carton Dimension (L) x (W) x (H) cm	37 x 21 x 13	37 x 36 x 6
Gross Weight	about 2.6 kgs	about 2.1 kgs

AN54LQ-10 Series

Model	Antenna	Photo
AN54LQ-10	Chip/Ceramic	
AN54LQ-P10	PCB/Printed	
AN54LQ-U10	U.FL/Connector	



- Unit weight of module:

AN54LQ-10 : 0.51 g (± 0.02 g) ; AN54LQ-P10 : 0.51 g (± 0.02 g) ; AN54LQ-U10 : 0.55 g (± 0.02 g) ;

- Packaging type: Tray or Tape & Reel.

	Tray	Tape & Reel
MPQ (Min. Package Q'ty)	88 pcs per tray	1,500 pcs per reel
Carton Contents (per carton)	1,760 pcs	1,500 pcs
Carton Dimension (L) x (W) x (H) cm	37 x 21 x 13	37 x 36 x 6
Gross Weight	about 2.6 kgs	about 2.1 kgs

AN54LQ-05 Series

Model	Antenna	Photo
AN54LQ-05	Chip/Ceramic	
AN54LQ-P05	PCB/Printed	
AN54LQ-U05	U.FL/Connector	

- Unit weight of module:

AN54LQ-05 : 0.51 g (± 0.02 g) ; AN54LQ-P05 : 0.51 g (± 0.02 g) ; AN54LQ-U05 : 0.55 g (± 0.02 g) ;

- Packaging type: Tray or Tape & Reel.

	Tray	Tape & Reel
MPQ (Min. Package Q'ty)	88 pcs per tray	1,500 pcs per reel
Carton Contents (per carton)	1,760 pcs	1,500 pcs
Carton Dimension (L) x (W) x (H) cm	37 x 21 x 13	37 x 36 x 6
Gross Weight	about 2.6 kgs	about 2.1 kgs

4.1. Marking on metal shield

Label context on metal shield is as below:

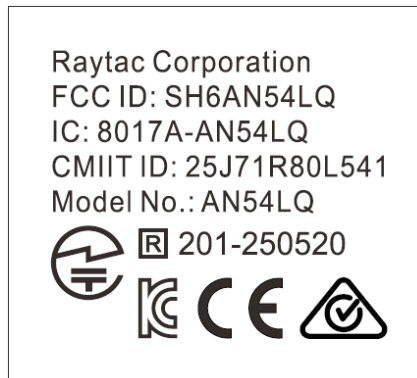

4.2. Packaging Info

4.2.1. Tray Packaging

Anti-static tray is specifically designed for mass production. It can be used directly on SMT automatic machine.

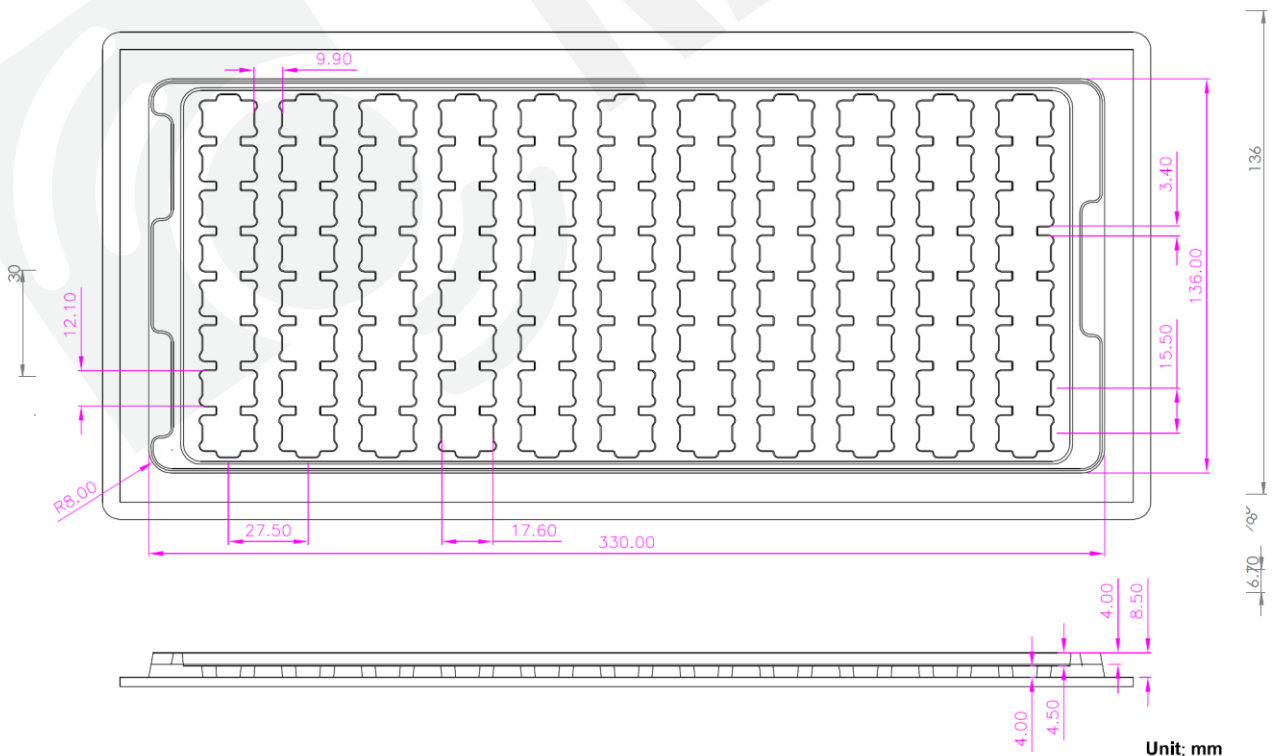

4.2.2. Reel packaging

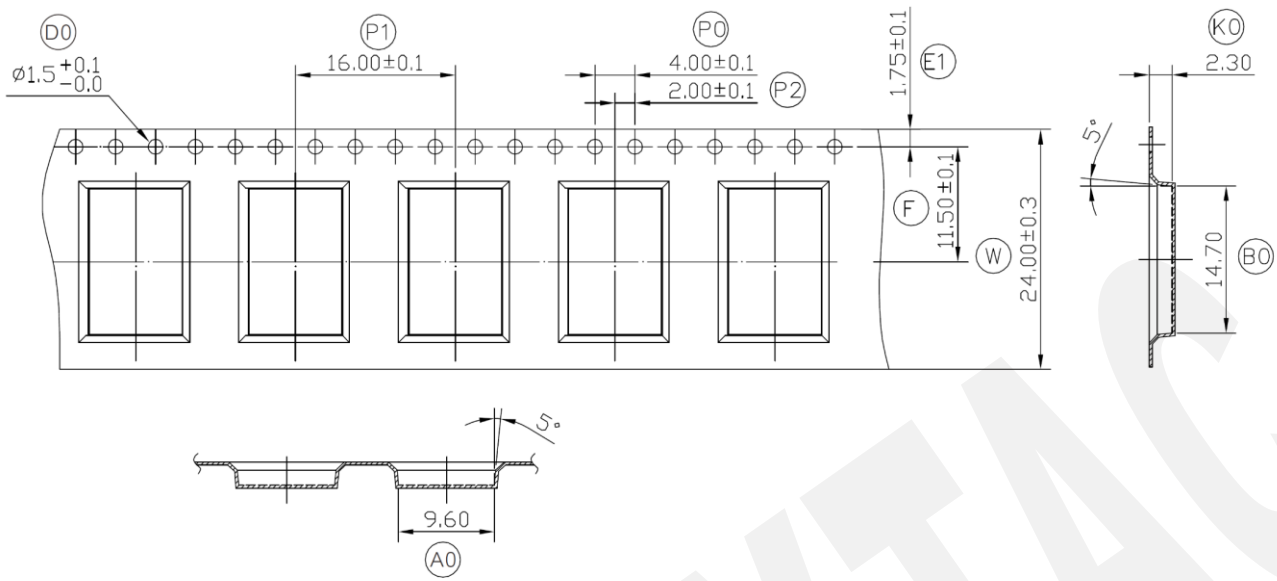

W	24.00	± 0.30
P1	16.00	± 0.10
E1	1.75	± 0.10
F	11.50	± 0.10
D0	1.50	$+0.1/-0$
P0	4.00	± 0.10
P2	2.00	± 0.10
A0	9.60	± 0.10
B0	14.70	± 0.10
K0	2.30	± 0.10
T	0.30	± 0.05

4.3. Order code

Each model has two options of packaging. Please use following part no. when placing order to us.

AN54LQ-15 Series

Model	Tray	Tape & Reel
AN54LQ-15	MD-240A8-001	MD-240A8-001R
AN54LQ-P15	MD-240A8-002	MD-240A8-002R
AN54LQ-U15	MD-240A8-003	MD-240A8-003R

MPQ of Reel packaging is 1,500 pcs and Tray packaging is 88 pcs.

AN54LQ-10 Series

Model	Tray	Tape & Reel
AN54LQ-10	MD-240A8-011	MD-240A8-011R
AN54LQ-P10	MD-240A8-012	MD-240A8-012R
AN54LQ-U10	MD-240A8-013	MD-240A8-013R

MPQ of Reel packaging is 1,500 pcs and Tray packaging is 88 pcs.

AN54LQ-05 Series

Model	Tray	Tape & Reel
AN54LQ-05	MD-240A8-014	MD-240A8-014R
AN54LQ-P05	MD-240A8-015	MD-240A8-015R
AN54LQ-U05	MD-240A8-016	MD-240A8-016R

MPQ of Reel packaging is 1,500 pcs and Tray packaging is 88 pcs.

5. Specification

Any technical spec shall refer to Nordic's official documents as final reference. Contents below are from "[nRF54L15 nRF54L10 nRF54L05 Product Specification v1.0](#)", please click to download full spec.

5.1. Recommended operating conditions

Symbol	Parameter	Min.	Nom.	Max.	Units
VDD	VDD supply voltage	1.7		3.6	V
VDD _{EXT}	VDD supply voltage under extended operating temperature	1.7		3.4	V
VDD _{POR}	VDD supply voltage needed during power-on reset	1.75			V
TA	Operating temperature	-40	25	85	°C
TA _{EXT}	Extended operating temperature	85		105	°C
T _{RST}	Recommended storage temperature			40	°C
RH _{RST}	Recommended storage relative humidity			90	%

The operating conditions are the physical parameters that the device can operate within.

5.2. Radio specifications

5.2.1. General radio characteristics

Symbol	Description	Min.	Typ.	Max.	Units
f _{OP}	Operating frequencies	2400		2500	MHz
f _{PLL,CH,SP}	Channel spacing		1.0		MHz
f _{DELTA,1M}	Frequency deviation @ 1 Mbps		±160		kHz
f _{DELTA,BLE,1M}	Frequency deviation @ Bluetooth LE 1 Mbps		±250		kHz
f _{DELTA,2M}	Frequency deviation @ 2 Mbps		±320		kHz
f _{DELTA,BLE,2M}	Frequency deviation @ Bluetooth LE 2 Mbps		±500		kHz
f _{DELTA,4M}	Frequency deviation @ 4 Mbps		±1000		kHz
f _{skBPS}	On-the-air data rate	125		4000	kbps
f _{chip, IEEE 802.15.4}	Chip rate in IEEE 802.15.4 mode		2000		kchip/s

5.2.2. Radio current consumption (Transmitter)

Symbol	Description	Min.	Typ.	Max.	Units
$I_{TX,MaxdBm,QFN}$	TX only run current for QFN package, P_{RF} at maximum power setting		9.1		mA
$I_{TX,MaxdBm,CSP}$	TX only run current for CSP package, P_{RF} at maximum power setting		9.7		mA
$I_{TX,0dBm}$	TX only run current, $P_{RF} = 0$ dBm		3.7		mA
$I_{TX,MINUS4dBm}$	TX only run current $P_{RF} = -4$ dBm		2.8		mA
$I_{TX,MINUS8dBm}$	TX only run current $P_{RF} = -8$ dBm		2.2		mA
$I_{TX,MINUS12dBm}$	TX only run current $P_{RF} = -12$ dBm		1.9		mA
$I_{TX,MINUS16dBm}$	TX only run current $P_{RF} = -16$ dBm		1.7		mA
$I_{TX,MINUS40dBm}$	TX only run current $P_{RF} = -40$ dBm		1.2		mA
$I_{START,TX}$	TX start-up current, $P_{RF} = 4$ dBm		..		mA

5.2.3. Radio current consumption (Receiver)

Symbol	Description	Min.	Typ.	Max.	Units
$I_{RX,1M}$	RX only run current, 1 Mbps/1 Mbps Bluetooth LE mode		2.1		mA
$I_{RX,2M}$	RX only run current, 2 Mbps/2 Mbps Bluetooth LE mode		2.1		mA
$I_{START,RX,1M}$	RX start-up current, 1 Mbps/1 Mbps Bluetooth LE mode		1.6		mA

5.2.4. Transmitter specification

Symbol	Description	Min.	Typ.	Max.	Units
$P_{RF,QFN}$	Maximum output power for QFN package		7		dBm
$P_{RF,CSP}$	Maximum output power for CSP package		8		dBm
P_{RFCR}	RF power accuracy	-2		2	dB
$P_{RF1,BLE1M,2MHZ}$	Adjacent Channel Transmit Power 2 MHz (1 Mbps Bluetooth LE mode)		-48		dBc
$P_{RF1,BLE1M,3MHZ}$	Adjacent Channel Transmit Power 3 MHz (1 Mbps Bluetooth LE mode)		-54		dBc
$P_{RF1,BLE2M,4MHZ}$	Adjacent Channel Transmit Power 4 MHz (2 Mbps Bluetooth LE mode)		-51		dBc
$P_{RF1,BLE2M,6MHZ}$	Adjacent Channel Transmit Power 6 MHz (2 Mbps Bluetooth LE mode)		-56		dBc
E_{vm}	Error vector magnitude in IEEE 802.15.4 mode		2		%rms
$P_{harm2nd, IEEE 802.15.4}$	2nd harmonics in IEEE 802.15.4 mode		-63		dBm
$P_{harm3rd, IEEE 802.15.4}$	3rd harmonics in IEEE 802.15.4 mode		-68		dBm

5.2.5. Receiver operation

Symbol	Description	Min.	Typ.	Max.	Units
$P_{RX,MAX}$	Maximum received signal strength at < 0.1% PER		0		dBm
$P_{SENS,IT,1M}$	Sensitivity, 1 Mbps nRF mode ideal transmitter ⁴		-93		dBm
$P_{SENS,IT,2M}$	Sensitivity, 2 Mbps nRF mode ideal transmitter ⁴		-90		dBm
$P_{SENS,IT,4M}$	Sensitivity, 4 Mbps nRF mode ideal transmitter ⁴		-90		dBm
$P_{SENS,IT,SP,1M,BLE}$	Sensitivity, 1 Mbps Bluetooth LE ideal transmitter, packet length ≤ 37 bytes BER = $1E-5$		-96 ⁶		dBm
$P_{SENS,IT,LP,1M,BLE}$	Sensitivity, 1 Mbps Bluetooth LE ideal transmitter, packet length ≥ 128 bytes BER = $1E-4$		-95		dBm
$P_{SENS,IT,SP,2M,BLE}$	Sensitivity, 2 Mbps Bluetooth LE ideal transmitter, packet length ≤ 37 bytes		-94		dBm
$P_{SENS,IT,BLE LE125k}$	Sensitivity, 125 kbps Bluetooth LE mode		-104		dBm
$P_{SENS,IT,BLE LE500k}$	Sensitivity, 500 kbps Bluetooth LE mode		-99		dBm
$P_{SENS,IEEE 802.15.4}$	Sensitivity in IEEE 802.15.4 mode		-102		dBm

⁴ Typical sensitivity applies when RXADDRESS.ADDR0 is used for receiver address. When RXADDRESS.ADDR[1...7] are used for receiver address, the typical sensitivity for this mode is degraded by 3 dB.

⁵ As defined in the *Bluetooth Core Specification v4.0 Volume 6: Core System Package (Low Energy Controller Volume)*.

⁶ QFN package sensitivity is degraded by approximately 1 dB compared to the provided value

5.2.6. RX selectivity

Symbol	Description	Min.	Typ.	Max.	Units
$C/I_{1M,co-channel}$	1Mbps mode, co-channel interference		9		dB
$C/I_{1M,-1MHz}$	1 Mbps mode, Adjacent (-1 MHz) interference		-4		dB
$C/I_{1M,+1MHz}$	1 Mbps mode, Adjacent (+1 MHz) interference		-9		dB
$C/I_{1M,-2MHz}$	1 Mbps mode, Adjacent (-2 MHz) interference		-28		dB
$C/I_{1M,+2MHz}$	1 Mbps mode, Adjacent (+2 MHz) interference		-40		dB
$C/I_{1M,-3MHz}$	1 Mbps mode, Adjacent (-3 MHz) interference		-39		dB
$C/I_{1M,+3MHz}$	1 Mbps mode, Adjacent (+3 MHz) interference		-43		dB
$C/I_{1M,\pm 6MHz}$	1 Mbps mode, Adjacent (≥ 6 MHz) interference		-48		dB
$C/I_{1MBLE,co-channel}$	1 Mbps Bluetooth LE mode, co-channel interference		6		dB
$C/I_{1MBLE,-1MHz}$	1 Mbps Bluetooth LE mode, Adjacent (-1 MHz) interference		-2		dB
$C/I_{1MBLE,+1MHz}$	1 Mbps Bluetooth LE mode, Adjacent (+1 MHz) interference		-6		dB
$C/I_{1MBLE,-2MHz}$	1 Mbps Bluetooth LE mode, Adjacent (-2 MHz) interference		-29		dB
$C/I_{1MBLE,+2MHz}$	1 Mbps Bluetooth LE mode, Adjacent (+2 MHz) interference		-43		dB
$C/I_{1MBLE,>3MHz}$	1 Mbps Bluetooth LE mode, Adjacent (≥ 3 MHz) interference		-46		dB
$C/I_{1MBLE,image}$	Image frequency interference		-29		dB
$C/I_{1MBLE,image,1MHz}$	Adjacent (1 MHz) interference to in-band image frequency		-39		dB
$C/I_{2M,co-channel}$	2 Mbps mode, co-channel interference		10		dB
$C/I_{2M,-2MHz}$	2 Mbps mode, Adjacent (-2 MHz) interference		-5		dB
$C/I_{2M,+2MHz}$	2 Mbps mode, Adjacent (+2 MHz) interference		-9		dB
$C/I_{2M,-4MHz}$	2 Mbps mode, Adjacent (-4 MHz) interference		-27		dB
$C/I_{2M,+4MHz}$	2 Mbps mode, Adjacent (+4 MHz) interference		-42		dB
$C/I_{2M,-6MHz}$	2 Mbps mode, Adjacent (-6 MHz) interference		-38		dB
$C/I_{2M,+6MHz}$	2 Mbps mode, Adjacent (+6 MHz) interference		-45		dB
$C/I_{2M,\geq 12MHz}$	2 Mbps mode, Adjacent (≥ 12 MHz) interference		-50		dB
$C/I_{2MBLE,co-channel}$	2 Mbps Bluetooth LE mode, co-channel interference		6		dB
$C/I_{2MBLE,-2MHz}$	2 Mbps Bluetooth LE mode, Adjacent (-2 MHz) interference		-2		dB
$C/I_{2MBLE,+2MHz}$	2 Mbps Bluetooth LE mode, Adjacent (+2 MHz) interference		-6		dB
$C/I_{2MBLE,-4MHz}$	2 Mbps Bluetooth LE mode, Adjacent (-4 MHz) interference		-29		dB
$C/I_{2MBLE,+4MHz}$	2 Mbps Bluetooth LE mode, Adjacent (+4 MHz) interference		-44		dB
$C/I_{2MBLE,\geq 6MHz}$	2 Mbps Bluetooth LE mode, Adjacent (≥ 6 MHz) interference		-46		dB

RX selectivity with equal modulation on interfering signal⁷

⁷ Desired signal level at $P_{IN} = -67$ dBm. One interferer is used, having equal modulation as the desired signal. The input power of the interferer where the sensitivity equals BER = 0.1% is presented.

Symbol	Description	Min.	Typ.	Max.	Units
C/I _{4M,co-channel}	4 Mbps mode, co-channel interference		6		dB
C/I _{4M,-4MHz}	4 Mbps mode, Adjacent (-4 MHz) interference		-4		dB
C/I _{4M,+4MHz}	4 Mbps mode, Adjacent (+4 MHz) interference		-11		dB
C/I _{4M,-8MHz}	4 Mbps mode, Adjacent (-8 MHz) interference		-27		dB
C/I _{4M,+8MHz}	4 Mbps mode, Adjacent (+8 MHz) interference		-46		dB
C/I _{4M,-12MHz}	4 Mbps mode, Adjacent (-12 MHz) interference		-40		dB
C/I _{4M,+12MHz}	4 Mbps mode, Adjacent (+12 MHz) interference		-50		dB
C/I _{4M,≥24MHz}	4 Mbps mode, Adjacent (≥24 MHz) interference		-56		dB
C/I _{2MBLE,image}	Image frequency interference		-29		dB
C/I _{2MBLE,image,2MHz}	Adjacent (2 MHz) interference to in-band image frequency		-38		dB
C/I _{125k BLE LR,co-channel}	125 kbps Bluetooth LE LR mode, co-channel interference		1		dB
C/I _{125k BLE LR,-1MHz}	125 kbps Bluetooth LE LR mode, Adjacent (-1 MHz) interference		-13		dB
C/I _{125k BLE LR,+1MHz}	125 kbps Bluetooth LE LR mode, Adjacent (+1 MHz) interference		-16		dB
C/I _{125k BLE LR,-2MHz}	125 kbps Bluetooth LE LR mode, Adjacent (-2 MHz) interference		-36		dB
C/I _{125k BLE LR,+2MHz}	125 kbps Bluetooth LE LR mode, Adjacent (+2 MHz) interference		-52		dB
C/I _{125k BLE LR,>3MHz}	125 kbps Bluetooth LE LR mode, Adjacent (≥3 MHz) interference		-55		dB
C/I _{125k BLE LR,image}	Image frequency interference		-36		dB
C/I _{IEEE 802.15.4,-5MHz}	IEEE 802.15.4 mode, Adjacent (-5 MHz) rejection		-35		dB
C/I _{IEEE 802.15.4,+5MHz}	IEEE 802.15.4 mode, Adjacent (+5 MHz) rejection		-38		dB
C/I _{IEEE 802.15.4,±10MHz}	IEEE 802.15.4 mode, Alternate (±10 MHz) rejection		-50		dB

5.2.7. RX intermodulation

Symbol	Description	Min.	Typ.	Max.	Units
P _{IMD,5TH,1M}	IMD performance, 1 Mbps, 5th offset channel, packet length ≤ 37 bytes				dBm
P _{IMD,5TH,1M,BLE}	IMD performance, Bluetooth LE 1 Mbps, 5th offset channel, packet length ≤ 37 bytes		-19		dBm
P _{IMD,5TH,2M}	IMD performance, 2 Mbps, 5th offset channel, packet length ≤ 37 bytes				dBm
P _{IMD,5TH,2M,BLE}	IMD performance, Bluetooth LE 2 Mbps, 5th offset channel, packet length ≤ 37 bytes		-16		dBm

RX intermodulation. Desired signal level at $P_{IN} = -64$ dBm. Two interferers with equal input power are used. The interferer closest in frequency is not modulated, the other interferer is modulated equal with the desired signal. The input power of the interferers where the sensitivity equals BER = 1E-3 is presented.

5.2.8. Radio timing parameters

Symbol	Description	Min.	Typ.	Max.	Units
$t_{TXEN,BLE,1M}$	Time between TXEN task and READY event after channel FREQUENCY configured (1 Mbps Bluetooth LE and 150 μ s TIFS)		140		μ s
$t_{TXEN,FAST,BLE,1M}$	Time between TXEN task and READY event after channel FREQUENCY configured (1 Mbps Bluetooth LE with fast ramp-up and 150 μ s TIFS)		40		μ s
$t_{TXDIS,BLE,1M}$	When in TX, delay between DISABLE task and DISABLED event for MODE = Nrf_1Mbit and MODE = Ble_1Mbit		2		μ s
$t_{RXEN,BLE,1M}$	Time between the RXEN task and READY event after channel FREQUENCY configured (1 Mbps Bluetooth LE)		134		μ s
$t_{RXEN,FAST,BLE,1M}$	Time between the RXEN task and READY event after channel FREQUENCY configured (1 Mbps Bluetooth LE with fast ramp-up)		40		μ s
$t_{RXDIS,BLE,1M}$	When in RX, delay between DISABLE task and DISABLED event for MODE = Nrf_1Mbit and MODE = Ble_1Mbit		1		μ s
$t_{TXDIS,BLE,2M}$	When in TX, delay between DISABLE task and DISABLED event for MODE = Nrf_2Mbit and MODE = Ble_2Mbit		2		μ s
$t_{RXDIS,BLE,2M}$	When in RX, delay between DISABLE task and DISABLED event for MODE = Nrf_2Mbit and MODE = Ble_2Mbit		1		μ s
$t_{TXEN,IEEE 802.15.4}$	Time between TXEN task and READY event after channel FREQUENCY configured (IEEE 802.15.4 mode)		130		μ s
$t_{TXEN,FAST,IEEE 802.15.4}$	Time between TXEN task and READY event after channel FREQUENCY configured (IEEE 802.15.4 mode with fast ramp-up)		40		μ s
$t_{TXDIS,IEEE 802.15.4}$	When in TX, delay between DISABLE task and DISABLED event (IEEE 802.15.4 mode)		18		μ s
$t_{RXEN,IEEE 802.15.4}$	Time between the RXEN task and READY event after channel FREQUENCY configured (IEEE 802.15.4 mode)		130		μ s
$t_{RXEN,FAST,IEEE 802.15.4}$	Time between the RXEN task and READY event after channel FREQUENCY configured (IEEE 802.15.4 mode with fast ramp-up)		40		μ s
$t_{RXDIS,IEEE 802.15.4}$	When in RX, delay between DISABLE task and DISABLED event (IEEE 802.15.4 mode)		0.2		μ s
$t_{RX\text{-to-TX turnaround, IEEE 802.15.4}}$	Maximum RX-to-TX turnaround time in IEEE 802.15.4 mode		17		μ s

5.2.9. RSSI specifications

Symbol	Description	Min.	Typ.	Max.	Units
RSSI _{ACC}	RSSI accuracy in the range -90 to -30 dBm		\pm 2		dB
RSSI _{RESOLUTION}	RSSI resolution		1		dB
RSSI _{PERIOD}	RSSI sampling time from RSSISTART task		0.25		μ s
RSSI _{SETTLE}	RSSI settling time after signal level change		15	20	μ s

5.3. Absolute maximum ratings

	Parameter	Min.	Max.	Unit
Supply voltage				
VDD	VDD supply voltage	-0.3	3.9	V
VDD _{EXT}	VDD supply voltage under extended operating temperature	-0.3	3.7	V
I/O pin voltage				
V _{I/O} , VDD ≤ 3.6 V	IO voltage	-0.3	VDD + 0.3	V
V _{I/O} , VDD > 3.6 V	IO voltage	-0.3	3.9	V
V _{I/O,EXT} , VDD _{EXT} ≤ 3.4 V	IO voltage under extended operating temperature	-0.3	VDD + 0.3	V
V _{I/O,EXT} , VDD _{EXT} > 3.4 V	IO voltage under extended operating temperature	-0.3	3.7	V
Radio				
RF input level			10	dBm
RRAM memory				
Endurance		10,000		Write/ rewrite cycles
Retention at 85°C		10		y
Retention at 105°C		2		y

	Note	Min.	Max.	Unit
Environmental QFN package types				
Storage temperature		-40	+125	°C
Reflow soldering temperature	Reflow cycle time is 30 seconds with 3 maximum reflow cycles.		260	°C
Moisture Sensitivity Level (MSL)			2	
ESD Human Body Model (HBM)			1	kV
ESD Charged Device Model (CDM)			500	V
Environmental CSP package types				
Storage temperature	Recommended storage condition is < 40°C and < 90% RH (relative humidity)	-40	+125	°C
Reflow soldering temperature	Reflow cycle time is 30 seconds with 3 maximum reflow cycles.		260	°C
Moisture Sensitivity Level (MSL)			1	
ESD Human Body Model (HBM)			3	kV
ESD Charged Device Model (CDM)			250	V

6. Block Diagram

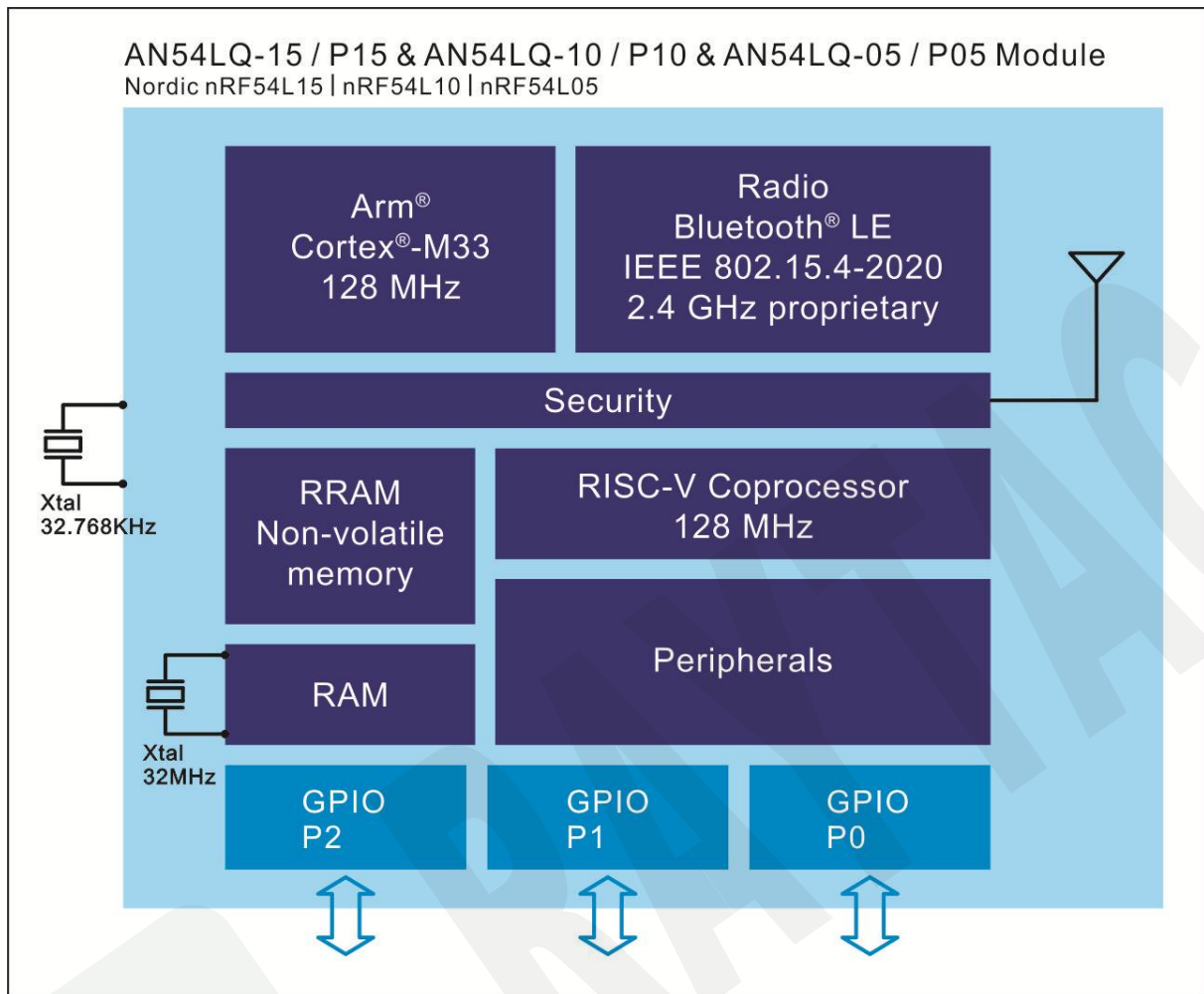

7. Reference circuit

Module is pre-programmed with Raytac's testing code. Default is using "DC-DC mode". The Nordic NCS firmware is set to use external 32.768KHz so please add it to make module work.

REMARK:

**** DECD decoupling capacitor (2.2μF) is already inside the module. ****

****When enabling the DC/DC regulator, the device checks if an inductor (L1) is connected to the DCC pin. If L1 is not detected, the device remains in LDO mode.****

**** When NOT using NFC, please remove NFC1 / C19 / C20. ****

**** When using internal 32.768KHz RC oscillator, please remove X2 / C12 / C13. ****

**** R39: Place close to the module. ****

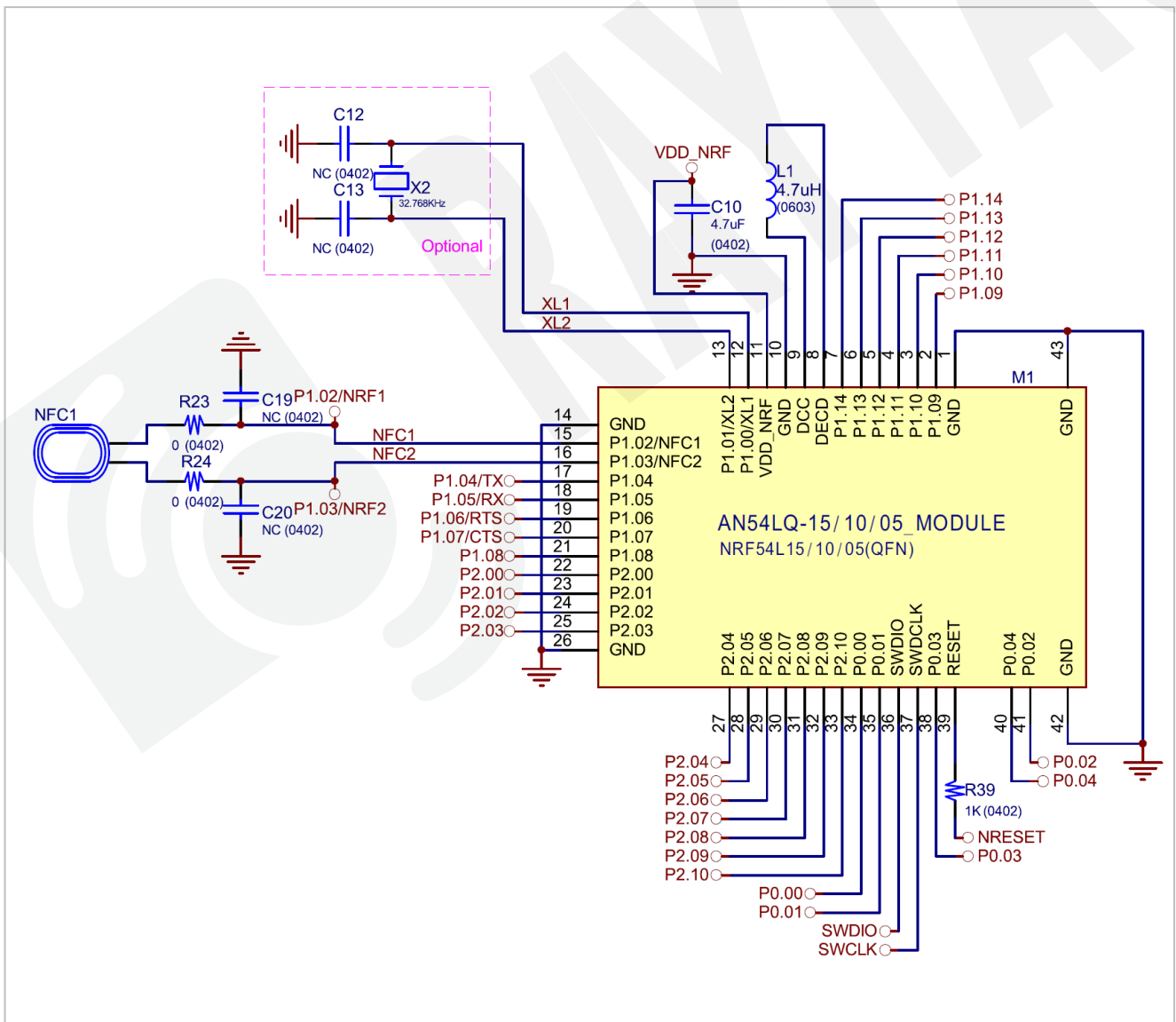

8. Certification

8.1. Declaration ID for Bluetooth

BT 6.0

Declaration ID	QDID(s) and Included DN(s)	Company	Specification Name
Q373526	Q360916 – Controller Subsystem Q361608 – Host Subsystem	Raytac Corporation	6.0

Profile Description	Service Description
Alert Notification Profile	Alert Notification Service
Blood Pressure Profile	Blood Pressure Service
	Device Information Service
Cycling Speed & Cadence Profile	Cycling Speed & Cadence Service
	Device Information Service
Glucose Profile	Glucose Service
	Device Information Service
Health Thermometer Profile	Health Thermometer Service
	Device Information Service
Heart Rate Profile	Heart Rate Service
	Device Information Service
HID over GATT Profile	HID Service
	Battery Service
	Link Loss Service
Proximity Profile	Immediate Alert Service
	TX Power Service
	Running Speed & Cadence Service
Running Speed & Cadence Profile	Device Information Service
	Time Profile Service
Time Profile	
Glucose Profile (Central)	
Mesh Profile	Mesh Provisioning Service
	Mesh Proxy Service

8.2. FCC Certificate (USA)

2.4GHz wireless module

				
TCB	TCB			
GRANT OF EQUIPMENT AUTHORIZATION Certification Issued Under the Authority of the Federal Communications Commission By:				
Kiwa Nederland B.V. Wilmersdorf 50 Apeldoorn, NL-7300 AC Netherlands				
Date of Grant: 07/30/2025 Application Dated: 07/23/2025				
Raytac Corp. 8F, No.788-1, Zhongzheng Rd., Zhonghe Dist., New Taipei City,, 235 Taiwan				
Attention: Lyon Liu , President				
NOT TRANSFERABLE EQUIPMENT AUTHORIZATION is hereby issued to the named GRANTEE, and is VALID ONLY for the equipment identified hereon for use under the Commission's Rules and Regulations listed below.				
FCC IDENTIFIER:	SH6AN54LQ			
Name of Grantee:	Raytac Corp.			
Equipment Class:	Digital Transmission System			
Notes:	Bluetooth Low Energy Module			
Modular Type:	Single Modular			
Grant Notes	FCC Rule Parts	Frequency Range (MHZ)	Output Watts	Frequency Emission Tolerance Designator
	15C	2402.0 - 2480.0	0.006	
<p>Power output listed is conducted. This grant is valid only when the module is sold to OEM integrators and must be installed by the OEM or OEM integrators. The antenna's as listed in this application must be installed to provide a separation distance of at least 20 cm from all persons and must not be co-located or operating in conjunction with any other antenna or transmitter. End-users may not be provided with the module installation instructions. OEM integrators and end-users must be provided with transmitter operating conditions for satisfying RF exposure compliance.</p>				
Certificate No.: 252181162/AA/00	Ron Scheepers Managing director			

SAR report



Report No.: TESA2502000154ES

Page: 1 of 9

RF EXPOSURE REPORT



Applicant: Raytac Corp.
8F, No.788-1, Zhongzheng Rd., Zhonghe Dist., New Taipei
City, 235, Taiwan

Manufacturer: Raytac Corp.
8F, No.788-1, Zhongzheng Rd., Zhonghe Dist., New Taipei
City, 235, Taiwan

Product Name: Bluetooth Low Energy Module

Brand Name: Raytac

Model No.: AN54LQ

Family Model No.: AN54LQ-P, AN54LQ-U

Model Difference: Dimensions, Antenna type

FCC ID SH6AN54LQ

IC: 8017A-AN54LQ

Date of EUT Received: Feb. 05, 2025

Issue Date: Jul. 21, 2025

Approved By _____

John Yeh
John Yeh

We hereby certify that:

The above equipment was evaluated by SGS Taiwan Ltd. The evaluation in this report is in compliance with FCC Rule Part §2.1091, KDB 447498 D01 v06 and RSS-102 issue 6.

The results of this report relate only to the sample identified in this report.

VERIFICATION OF COMPLIANCE

Issue Date: Jul. 11, 2025
Applicant: Raytac Corp.
Address: 8F, No.788-1, Zhongzheng Rd., Zhonghe Dist., New Taipei City, 235, Taiwan
Manufacturer: Raytac Corp.
Address: 8F, No.788-1, Zhongzheng Rd., Zhonghe Dist., New Taipei City, 235, Taiwan
Product: Bluetooth Low Energy Module
Brand Name/Trade Mark: Raytac
Model/Type: AN54LQ
Added Model(s): AN54LQ-P, AN54LQ-U
Applicable Standards: 47 CFR FCC Part 15 Subpart B
ICES-003 Issue 7 : October 2020
ANSI C63.4 : 2014
Test Laboratory: SGS Taiwan Ltd.
Electromagnetic Compatibility Laboratory
No.2, Keji 1st Rd., Guishan District, Taoyuan City, Taiwan
Test Report No.: TMHY2502000327YE, dated on Jul. 11, 2025

Conclusion: Based upon a review of the Test Report(s), the tested sample of the product mentioned above is deemed to comply with the requirements of the above standards.

Note: This verification is only valid for the product and configuration described and in conjunction with the test report as detailed above.

Authorised Signatory:



SGS Taiwan Ltd.
Eddy Cheng
Asst. Supervisor

8.3. TELEC Certificate (Japan)

1 Mbps & 2 Mbps

	
	Certificate of Radio Equipment in JAPAN 201-250520 / 00
	Issued 25 July 2025
	Page 1 of 5 This certificate has THREE Annexes
	<p>Kiwa Nederland B.V., operating as Japan Conformity Assessment Body (CAB ID Number: 201), according procedure RD_740, declares that the listed product complies with the Technical Regulations Conformity Certification of Specified Radio equipment (ordinance of MPT N° 37,1981)</p>
	Product description: Bluetooth Low Energy Module
	Trademark: Raytac
	Type designation: AN54LQ
	Hardware / Software: 1 / 1
	Variants: See Annex 3
Manufacturer: Raytac Corp.	
Address: 8F., No. 788-1, Zhongzheng Rd., Zhonghe Dist.,	
City: 235 New Taipei City	
Country: Taiwan	
This certificate is granted to:	
Name: Raytac Corp.	
Address: 8F., No. 788-1, Zhongzheng Rd., Zhonghe Dist.,	
City: 235 New Taipei City	
Country: Taiwan	
	
Ron Scheepers Managing director	
<p>Kiwa Nederland B.V. Wilmersdorf 50 Postbus 137 7300 AC Apeldoorn The Netherlands</p> <p>https://www.kiwa.com/nl/en/markets/ radio-wireless-and-electrical- equipment/</p> <p>Chamber of commerce 08090048</p> 	

8.4. NCC Certificate (Taiwan)

1 Mbps & 2 Mbps

AN54LQ

SGS

台灣檢驗科技股份有限公司
電信管制射頻器材型式認證證明



證照字號：型式字第 AM 號

- 一、申請者：勁達國際電子股份有限公司
- 二、地址：臺北市大安區和平東路1段145號5樓之1
- 三、製造廠商：勁達國際電子股份有限公司
- 四、器材名稱：藍牙模組
- 五、廠牌：Raytac
- 六、型號：AN54LQ
- 七、發射功率(電場強度)：詳細射頻規格如備註欄
- 八、工作頻率：詳細射頻規格如備註欄
- 九、審驗日期：114年07月28日

十、審驗合格標籤式樣：

 CCAM25Y10170T6



- 十一、警語或標示要求：(器材本體、使用手冊、外包裝盒等應遵守下列標示要求)
 1. 應於本體明顯處標示審驗合格標籤或符合性聲明標籤及其型號，並於包裝盒標示主管機關標章。最終產品應於本體明顯處標示非隨插即用射頻模組(組件)之審驗合格標籤及最終產品型號，並於包裝盒標示主管機關標章，始得販賣。
 2. 依主管機關或相關技術規範規定於指定位置標示正體中文警語。
 3. 經授權使用射頻模組(組件)之審驗合格標籤者，應於最終產品說明書及包裝盒提供充分與正確之資訊。
 4. 於網際網路販賣電信管制射頻器材者，應於該網際網路網頁標示其型號及審驗合格標籤或符合性聲明標籤資訊。但最終產品得僅標示其型號及其組裝之非隨插即用射頻模組(組件)之審驗合格標籤資訊。
 5. 使用手冊應標示下列資訊：
 - (1) 取得審驗證明之低功率射頻器材，非經核准，公司、商號或使用者均不得擅自變更頻率、加大功率或變更原設計之特性及功能。低功率射頻器材之使用不得影響飛航安全及干擾合法通信；經發現有干擾現象時，應立即停用，並改善至無干擾時方得繼續使用。前述合法通信，指依電信管理法規定作業之無線電通信。低功率射頻器材須忍受合法通信或工業、科學及醫療用電波輻射性電機設備之干擾。

AN54LQ-P

台灣檢驗科技股份有限公司 電信管制射頻器材型式認證證明



證照字號：型式字第 AM 號

- 一、申請者：勁達國際電子股份有限公司
- 二、地址：臺北市大安區和平東路1段145號5樓之1
- 三、製造廠商：勁達國際電子股份有限公司
- 四、器材名稱：藍牙模組
- 五、廠牌：Raytac
- 六、型號：AN54LQ-P
- 七、發射功率(電場強度)：詳細射頻規格如備註欄
- 八、工作頻率：詳細射頻規格如備註欄
- 九、審驗日期：114年07月28日

- 十、審驗合格標籤式樣：

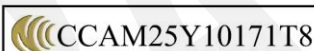

- 十一、警語或標示要求：(器材本體、使用手冊、外包裝盒等應遵守下列標示要求)
1. 應於本體明顯處標示審驗合格標籤或符合性聲明標籤及其型號，並於包裝盒標示主管機關標章。最終產品應於本體明顯處標示非隨插即用射頻模組(組件)之審驗合格標籤及最終產品型號，並於包裝盒標示主管機關標章，始得販賣。
 2. 依主管機關或相關技術規範規定於指定位置標示正體中文警語。
 3. 經授權使用射頻模組(組件)之審驗合格標籤者，應於最終產品說明書及包裝盒提供充分與正確之資訊。
 4. 於網際網路販賣電信管制射頻器材者，應於該網際網路網頁標示其型號及審驗合格標籤或符合性聲明標籤資訊。但最終產品得僅標示其型號及其組裝之非隨插即用射頻模組(組件)之審驗合格標籤資訊。
 5. 使用手冊應標示下列資訊：
 - (1) 取得審驗證明之低功率射頻器材，非經核准，公司、商號或使用者均不得擅自變更頻率、加大功率或變更原設計之特性及功能。低功率射頻器材之使用不得影響飛航安全及干擾合法通信；經發現有干擾現象時，應立即停用，並改善至無干擾時方得繼續使用。前述合法通信，指依電信管理法規定作業之無線電通信。低功率射頻器材須忍受合法通信或工業、科學及醫療用電波輻射性電機設備之干擾。

AN54LQ-U

SGS

台灣檢驗科技股份有限公司 電信管制射頻器材型式認證證明



證照字號：型式字第 AM 號

- 一、申請者：勁達國際電子股份有限公司
- 二、地址：臺北市大安區和平東路1段145號5樓之1
- 三、製造廠商：勁達國際電子股份有限公司
- 四、器材名稱：藍牙模組
- 五、廠牌：Raytac
- 六、型號：AN54LQ-U
- 七、發射功率(電場強度)：詳細射頻規格如備註欄
- 八、工作頻率：詳細射頻規格如備註欄
- 九、審驗日期：114年07月28日

- 十、審驗合格標籤式樣：

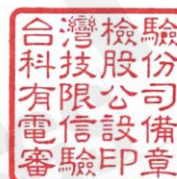

- 十一、警語或標示要求：(器材本體、使用手冊、外包裝盒等應遵守下列標示要求)
1. 應於本體明顯處標示審驗合格標籤或符合性聲明標籤及其型號，並於包裝盒標示主管機關標章。最終產品應於本體明顯處標示非隨插即用射頻模組(組件)之審驗合格標籤及最終產品型號，並於包裝盒標示主管機關標章，始得販賣。
 2. 依主管機關或相關技術規範規定於指定位置標示正體中文警語。
 3. 經授權使用射頻模組(組件)之審驗合格標籤者，應於最終產品說明書及包裝盒提供充分與正確之資訊。
 4. 於網際網路販賣電信管制射頻器材者，應於該網際網路網頁標示其型號及審驗合格標籤或符合性聲明標籤資訊。但最終產品得僅標示其型號及其組裝之非隨插即用射頻模組(組件)之審驗合格標籤資訊。
 5. 使用手冊應標示下列資訊：
 - (1) 取得審驗證明之低功率射頻器材，非經核准，公司、商號或使用者均不得擅自變更頻率、加大功率或變更原設計之特性及功能。低功率射頻器材之使用不得影響飛航安全及干擾合法通信；經發現有干擾現象時，應立即停用，並改善至無干擾時方得繼續使用。前述合法通信，指依電信管理法規定作業之無線電通信。低功率射頻器材須忍受合法通信或工業、科學及醫療用電波輻射性電機設備之干擾。

RF EXPOSURE REPORT



Applicant: Raytac Corp.
8F, No.788-1, Zhongzheng Rd., Zhonghe Dist., New Taipei
City, 235, Taiwan

Manufacturer: Raytac Corp.
8F, No.788-1, Zhongzheng Rd., Zhonghe Dist., New Taipei
City, 235, Taiwan

Product Name: Bluetooth Low Energy Module

Brand Name: Raytac

Model No.: AN54LQ

Family Model No.: AN54LQ-P, AN54LQ-U

Model Difference: Dimensions, Antenna type

Date of EUT Received: Feb. 05, 2025

Issue Date: Jul. 21, 2025

Approved By _____



John Yeh
John Yeh

We hereby certify that:

The above equipment was evaluated by SGS Taiwan Ltd. for compliance with the requirements set forth in the European Standard EN 62479:2010, EN 50663: 2017 and Australia/New Zealand Standard AS/NZS 2772.2:2016.

The results in this report apply to this specific product system.

TEST REPORT IEC/EN 62368-1 Audio/video, information and communication technology equipment Part 1: Safety requirements	
Report Number	TSSF2502000091L0
Date of issue	2025-07-14
Total number of pages	50
Name of Testing Laboratory preparing the Report	SGS Taiwan Ltd. Safety Laboratory
Applicant's name	Raytac Corp.
Address	8F, No.788-1, Zhongzheng Rd., Zhonghe Dist., New Taipei City, 235, Taiwan
Test specification:	
Standard	IEC 62368-1:2018 and EN IEC 62368-1:2020+A11:2020
Test procedure	Commission testing
Non-standard test method	N/A
TRF template used	IECEE OD-2020-F1:2021, Ed.1.4
Test Report Form No.	IEC62368_1F modify by SGS TW (EN)
Test Report Form(s) Originator	UL(US)
Master TRF	Dated 2023-08-17
Copyright © 2021 IEC System of Conformity Assessment Schemes for Electrotechnical Equipment and Components (IECEE System). All rights reserved. This publication may be reproduced in whole or in part for non-commercial purposes as long as the IECEE is acknowledged as copyright owner and source of the material. IECEE takes no responsibility for and will not assume liability for damages resulting from the reader's interpretation of the reproduced material due to its placement and context.	
General disclaimer:	
The test results presented in this report relate only to the object tested. This report shall not be reproduced, except in full, without the written approval of the Issuing CB Testing Laboratory. The authenticity of this Test Report and its contents can be verified by contacting the NCB, responsible for this Test Report.	

Test item description	Bluetooth Low Energy Module	
Trade Mark(s)	Raytac	
Manufacturer	Raytac Corp. 8F, No.788-1, Zhongzheng Rd., Zhonghe Dist., New Taipei City, 235, Taiwan	
Model/Type reference	AN54LQ, AN54LQ-P, AN54LQ-U	
Ratings	3.3Vdc	
Responsible Testing Laboratory (as applicable), testing procedure and testing location(s):		
<input type="checkbox"/> Testing Laboratory:	SGS Taiwan Ltd., Safety Laboratory	
Testing location/ address	No. 33, Wu Chyuan Road, New Taipei Industrial Park, Wu Ku District, New Taipei City 24886, Taiwan	
Tested by (name, function, signature)	Jeffrey Liang Project handler	
Approved by (name, function, signature) ..	Kenny Cheng Reviewer	

VERIFICATION OF COMPLIANCE

Issue Date: Jul. 11, 2025
Applicant: Raytac Corp.
Address: 8F, No.788-1, Zhongzheng Rd., Zhonghe Dist., New Taipei City, 235, Taiwan
Manufacturer: Raytac Corp.
Address: 8F, No.788-1, Zhongzheng Rd., Zhonghe Dist., New Taipei City, 235, Taiwan
Product: Bluetooth Low Energy Module
Brand Name/Trade Mark: Raytac
Model/Type: AN54LQ
Added Model(s): AN54LQ-P, AN54LQ-U
Applicable Standards: EN 301 489 –1 v2.2.3 : 2019-11
EN 301 489 –17 v3.3.1 : 2024-09
EN 55032 : 2015+A11:2020
EN IEC 61000-3-2 : 2019+A1:2021
EN 61000-3-3 : 2013+A1:2019+A2:2021+AC:2022-01
EN 61000-4-2 : 2009
EN IEC 61000-4-3 : 2020
EN 61000-4-4 : 2012
EN 61000-4-6 : 2014+AC:2015
Test Laboratory: SGS Taiwan Ltd.
Electromagnetic Compatibility Laboratory
No.2, Keji 1st Rd., Guishan District, Taoyuan City, Taiwan
Test Report No.: TMHY2502000325YE, dated on Jul. 11, 2025

Conclusion: Based upon a review of the Test Report(s), the tested sample of the product mentioned above is deemed to comply with the requirements of the above standards.

Note: This verification is only valid for the product and configuration described and in conjunction with the test report as detailed above.

Authorised Signatory:



SGS Taiwan Ltd.
Eddy Cheng
Asst. Supervisor

RCM SDoc

Supplier's declaration of conformity



This is the Australian Communications and Media Authority (ACMA) approved form for a declaration of conformity under the following legislative instruments:

- > Radiocommunications Equipment (General) Rules 2021
- > Radiocommunications Labelling (Electromagnetic Compatibility) Notice 2017.

This is a sample form for a declaration of conformity under the Telecommunications (Labelling Notice for Customer Equipment and Customer Cabling) Instrument 2025.

Instructions for completion

Do not return this form to the ACMA. This completed form must be retained by the supplier as part of the documentation required for the compliance records. However, it must be made available for inspection by the ACMA when requested.

Supplier's details (manufacturer, importer or authorised agent)

Company name (or individual)

N121 PTY LTD

ACN/ARBN

646 997 373

Street address (Australia or New Zealand)

UNIT 5, 25-31 ALEXANDRA STREET
DRUMMOYNE NSW 2047, AUSTRALIA

Product details and date of manufacture

Product description – brand name, type, current model, lot, batch or serial number (if available), software/firmware version (if applicable)

Equipment name: Bluetooth Low Energy Module

Model name: AN54LQ

Variant model name: AN54LQ-P, AN54LQ-U

Brand name: Raytac

Compliance – applicable standards and other supporting documents

Evidence of compliance with applicable standards may be demonstrated by test reports, endorsed/accredited test reports, certification/competent body statements.

Having had regard to these documents, I am satisfied the above-mentioned product complies with the requirements of the relevant ACMA standards made under the *Radiocommunications Act 1992* and/or the *Telecommunications Act 1997*.

List these documents including details of the standard title, number and, if applicable, number of the test report/endorsed test report or certification/competent body statement.

Standard	Report number
Radiocommunications Labelling (Electromagnetic Compatibility) Notice 2017 (AS/NZS CISPR 32:2015+A1:2020)	TMHY2502000326YE
Radiocommunications Equipment (General) Rules 2021	TERF2508002564E2

Declaration

I hereby declare that:

1. I am authorised to make this declaration on behalf of the Company mentioned above
2. the contents of this form are true and correct
3. the product mentioned above complies with the applicable above mentioned standards and all products supplied under this declaration will be identical to the product identified above
4. I understand that giving false or misleading information is a serious offence.

Note: It is an offence to knowingly provide false or misleading information to a Commonwealth entity or a person who is exercising powers, performing functions under, or in connection with, a law of the Commonwealth. It is an offence to knowingly provide false or misleading information or documents in compliance or purported compliance with a law of the Commonwealth. (See sections 137.1 and 137.2 of the *Criminal Code Act 1995*.)

Penalty: 12 months imprisonment

Signature of Authorised Person	Date	Print Name	Position
	August 19, 2025	Daniel	Managing Director

The *Privacy Act 1988* (Cth) (the Privacy Act) imposes obligations on the ACMA in relation to the collection, security, quality, access, use and disclosure of personal information. These obligations are detailed in the Australian Privacy Principles.

The ACMA may only collect personal information if it is reasonably necessary for, or directly related to, one or more of the ACMA's functions or activities.

The purpose of collecting the personal information in this form is to ensure the supplier is identified in the 'declaration of conformity'. If this declaration of conformity is not completed and the requested information is not provided, a compliance label cannot be applied.

Further information on the Privacy Act and the ACMA's privacy policy is available at www.acma.gov.au/privacypolicy. The privacy policy contains details about how you may access personal information about you that is held by the ACMA, and seek the correction of such information. It also explains how you may complain about a breach of the Privacy Act and how we will deal with such a complaint.

Should you have any questions in this regard, please contact the ACMA's privacy contact officer on telephone on 1800 226 667 or by email at privacy@acma.gov.au.

Supplier's Declaration of Conformity

Section 134 (1) (g) of the New Zealand Radiocommunications Act 1989

Supplier's Details:

Name: JNM NZ LIMITED

Supplier Number: E9659

New Zealand Company Number: 8308895

Address: 1 Mariner Lane Beachlands2018 New Zealand

Product Details:

Brand name (Manufacture name)	Raytac		
Product name (Description)	Bluetooth Low Energy Module	Model name	AN54LQ
		Variant model	AN54LQ-P, AN54LQ-U
Frequency	2 402 MHz ~ 2 480 MHz	Radiated power e.i.r.p (dBm):	9.86 dBm
Applicable Standards Title, Number and Edition	AS/NZS CISPR 32:2015+A1:2020 AS/NZS 4268:2017:AMD1:2021 ETSI EN 300 328 V 2.2.2		
Test Report Numbers	TMHY2502000326YE TERF2508002564E2		

I hereby declare that the product to which this Declaration of conformity relates complies with the above-mentioned standard(s), and all products supplied under this Declaration will be identical to the sample identified in this Declaration.



Daniel
Director
05 August 2025

8.6. IC Certificate (Canada)

2.4GHz wireless module

CERTIFICATE		CB	TECHNICAL ACCEPTANCE CERTIFICATE CERTIFICAT D'APPROBATION TECHNIQUE			
		▶ Reg. No. NL0001				
		CERTIFICATION No No. DE CERTIFICATION	8017A-AN54LQ			
		Issued	30 July 2025			
		Page	1 of 2 This certificate has ONE Annex			
		KIWA No. No. DE KIWA	252170402/AA/00			
		TEST SITE No. No. DE LABORATOIRE	4620E			
		ISSUED TO DÉLIVRÉ A	Raytac Corp. 8F, No.788-1, Zhongzheng Rd., Zhonghe Dist. New Taipei City 235 Taiwan			
		TYPE OF EQUIPMENT GENRE DE MATÉRIEL	Bluetooth device			
		TRADE NAME MARQUE	Raytac			
	MODEL (HVIN) MODELE (HVIN)	AN54LQ, AN54LQ-P, AN54LQ-U				
	FVIN	1				
	PMN	AN54LQ, AN54LQ-P, AN54LQ-U				
	CERTIFIED TO CERTIFIÉ SELON LE	SPECIFICATION CAHIER DES CHARGES	RSS-102 RSS-247	ISSUE EDITION	6 3	
	ISSUED BY KIWA NEDERLAND B.V. (NL0001), RECOGNIZED CERTIFICATION BODY BY INNOVATION, SCIENCE AND ECONOMIC DEVELOPMENT CANADA, ACCORDING THE CANADIAN CERTIFICATION BODY SCHEME (REC-CB). DÉLIVRÉ PAR KIWA NEDERLAND B.V. (NL0001), ORGANISME DE CERTIFICATION RECONNU PAR INNOVATION, SCIENCES ET DÉVELOPPEMENT ÉCONOMIQUE CANADA, SELON LE SYSTÈME D'ORGANISME DE CERTIFICATION DE CANADA (REC-CB).					
	I hereby attest that the subject equipment was tested and found to be in compliance with the noted specification. J'atteste, par la présente, que le matériel a fait l'objet d'essai et a été jugé conforme à la spécification indiquée.					
						
	David Chen Reviewer	George Chen Decision maker				
	<small>Kiwa Nederland B.V. Wilmsdorf 50 Postbus 137 7300 AC Apeldoorn The Netherlands https://www.kiwa.com/nl/en/markets/radio-wireless-and-electrical-equipment/ Chamber of commerce 08090048</small>					

8.7. SRRC Certificate (China)

编号: 2025-17811
Certificate No.

无线电发射设备型号核准证

Radio Transmission Equipment Type Approval Certificate

劲达国际电子股份有限公司 (台湾):

根据《中华人民共和国无线电管理条例》, 经审查, 下列设备准予颁发无线电发射设备型号核准证。

In accordance with the Radio Regulations of the People's Republic of China, after examination, the Radio Transmission Equipment Type Approval Certificate is granted to the following equipment.

设备名称:	蓝牙模块
Equipment Name	
设备型号:	AN54LQ
Equipment Type	
核准代码:	25J71R80L541
CMIIT ID	
主要功能:	数据传输
Main Functions	
有效期:	2030-04-03
Validity	
其他事项载于附页。	
Additional Items as Seen in Attachments.	



Sealed by Issuing Authority

2025年 08月 15日

Year Month Date

中华人民共和国工业和信息化部统一制作

Issued by the Ministry of Industry and Information Technology of the People's Republic of China

编号: 2025-17817
Certificate No.

无线电发射设备型号核准证

Radio Transmission Equipment Type Approval Certificate

劲达国际电子股份有限公司 (台湾):

根据《中华人民共和国无线电管理条例》, 经审查, 下列设备准予颁发无线电发射设备型号核准证。

In accordance with the Radio Regulations of the People's Republic of China, after examination, the Radio Transmission Equipment Type Approval Certificate is granted to the following equipment.

设备名称:	蓝牙模块
Equipment Name	
设备型号:	AN54LQ-U
Equipment Type	
核准代码:	25J71R80L542 (M)
CMIIT ID	
主要功能:	数据传输
Main Functions	
有效期:	2030-04-03
Validity	

其他事项载于附页。
Additional Items as Seen in Attachments.



Sealed by Issuing Authority
2025年08月15日
Year Month Date

中华人民共和国工业和信息化部统一制作
Issued by the Ministry of Industry and Information Technology of the People's Republic of China

8.8. KC Certificate (South Korea)

2.4GHz wireless module

038F-75EF-DD68-7C60

방송통신기자재등의 적합등록 필증 <i>Registration of Broadcasting and Communication Equipments</i>	
상호 또는 성명 Trade Name or Registrant	Raytac Corporation
기자재명칭(제품명칭) Equipment Name	Bluetooth Low Energy Module
기기부호/추가 기기부호 Equipment code /Additional Equipment code	LARN8
기본모델명 Basic Model Number	AN54LQ-U
파생모델명 Series Model Number	AN54LQ, AN54LQ-P
등록번호 Registration No.	R-R-ryt-AN54LQ
제조사/제조국가 Manufacturer/Country of Origin	Raytac Corporation/대만
등록연월일 Date of Registration	2025-07-28
기타 Others	<small>기본모델명: AN54LQ-U External Antenna Single Antenna Type 1) 제조사: Aristelle 모델명: RFA-02-S-P17K18000 안테나 이득(dBi): 3.0 2) 제조사: YAGEO 모델명: ANTX180P11824003 안테나 이득(dBi): 3.3 3) 제조사: YAGEO 모델명: ANTX180PP11824003 안테나 이득(dBi): 2.2 4) 제조사: YAGEO 모델명: ANTX180ET0824553 안테나 이득(dBi): 2.22 파생모델명: AN54LQ Internal Antenna Monopole antenna Type 1) 제조사: Raytac Corp. 안테나 이득(dBi): 1.42 파생모델명: AN54LQ-P Internal Antenna PIFA antenna Type 1) 제조사: Raytac Corp. 안테나 이득(dBi): 0.00</small>
<p>위 기자재는 「전파법」 제58조의2 제3항에 따라 등록되었음을 증명합니다. It is verified that foregoing equipment has been registered under the Clause 3, Article 58-2 of Radio Waves Act.</p> <p style="text-align: right;">2025년(Year) 08월(Month) 07일(Day)</p> <p style="text-align: center;">국립전파연구원  Director General of National Radio Research Agency</p> <p style="text-align: center; color: red;">※ 적합등록 방송통신기자재는 반드시 "적합성평가표시" 를 부착하여 유통하여야 합니다. 위반시 과태료 처분 및 등록이 취소될 수 있습니다.</p>	

8.9. WPC Certificate (India)



Government of India
Ministry of Communications
Department of Telecommunications
WPC Wing
Sanchar Bhawan, New Delhi-110001.

[Generation of Equipment Type Approval (ETA) through self-declaration issued under O.M. No. ETA-WPC /Policy/2018-19 dated 26 February, 2019].

THIS ETA IS ISSUED FOR A SINGLE MODEL WITH MODEL NAME AN54LQ (AN54LQ-P AN54LQ-U)

Registration No: ETA-SD-20250807326

Date: 01-09-2025

D). Details of Applicant and Parameters of Equipment:

1.	Name & Address of the first Applicant. (Indian Manufacturer/ Authorised Indian representative for foreign manufacturer)	ATOLL SOLUTIONS PRIVATE LIMITED, No. 143, First Floor, 10th Cross 1st Stage, Indiranagar Bangalore Bangalore, Bangalore Urban,KARNATAKA,560038
2.	Equipment category	Bluetooth module
3.	Make	Raytac Corporation,Taiwan
4.	Model	AN54LQ (AN54LQ-P AN54LQ-U)
5.	Frequency range(s) of Equipment	1. 2402-2480 MHz
6.	Max output power/Field strength/PSD	1. E.I.R.P. (Watts). 0.006

7.	Applicable Gazette Notification(s)	1. 1047 (E) Dated 18-10-2018	
8.	RF Test Report details:-		
	Name&Address /Country of accredited laboratory issuing the RF test report	Accreditation Certificate Reference/Number	Test Report No. and Date
	SGS Taiwan Ltd & No134, Wu Kung Road,New Taipei Industrial Park, Wuku District, New Taipei City, Taiwan	252181162/AA/00	TERF2502000650E2 & 18-07-2025

II). Terms and Conditions

- (i). This certificate will not be valid in case any change in the above parameters and not conforming to the Gazette Notification mentioned in sl.no 7 above.
- (ii). Use of such equipment has been exempted from licensing requirement vide Gazette Notification mentioned in sl. no. 7, on Non-interference,Non-protectionand sharing (non-exclusive) basis.
- (iii). Use of such equipment in case not conforming to above notification will require a specific wireless operating license, as applicable from this Ministry.
- (iv). Field units of WPC Wing reserve the right for sample check/audit carried out for the purpose of RF analysis/spectrum monitoring in view to avoid interference to other wireless users and ensure compliance of technical parameters mentioned in sl no. 5,6&7.
- (v). This certificate is valid only for equipment which are exempted from import licensing requirements as per the Import Policy of DGFT and for import of such device, a self-declaration based, system generated (Saralsanchar) Import undertaking/ permission is required.
- (vi). The applicant is liable for prosecution under Indian Law in case of any wrong declaration/ submission of ingenuine RF test report(s) for issue of ETA through Self-Declaration.

Note:

1. Once ETA through self-declaration is generated for a model, subsequently it may be utilized by other person(s) for import/usage purpose in India.
2. The importers of above model shall comply with other import related requirements, if any, with Customs.

This is Self-generated certificate. Hence, no signature is required. It may be downloaded/verified from the website <https://saralsanchar.gov.in>.

8.10. EU and UKCA Declarations of Conformity

The product complies with the applicable requirements of both the European Union and United Kingdom regulations, including the essential requirements of the following directives:

- **Radio Equipment Directive: 2014/53/EU**
- **RoHS Directive: 2011/65/EU Annex II and its amendment Directive (EU) 2015/863**

Conformity is demonstrated with reference to the following harmonized standards, based on test reports issued by SGS Taiwan Ltd.:

- **EN 300 328 V2.2.2:2019**
- **EN 301 489-1 V2.2.3 : 2019-11**
- **EN 301 489-17 V3.3.1 : 2024-09**
- **EN 301 893 v2.1.1**
- **EN 55032 : 2015+A11:2020**
- **EN IEC 61000-3-2 : 2019+A1:2021**
- **EN 61000-3-3 : 2013+A1:2019+A2:2021+AC:2022-01**
- **EN 61000-4-2 : 2009**
- **EN 61000-4-3 : 2020**
- **EN IEC 61000-4-3 : 2020**
- **EN 61000-4-4 : 2012**
- **EN 61000-4-6 : 2014+AC:2015**
- **IEC 62368-1 : 2018+A11:2020**

RoHS compliance reports were issued by **TÜV Rheinland Hong Kong Ltd.**, covering Directive 2011/65/EU and its amendment Directive (EU) 2015/863.

8.11. RoHS & REACH report

Please visit "[Support](#)" page of our website to download.

8.12. End-product label

It is suggested using following content adding to package or user manual or label to obey the regulation. Any rules of end-product label shall refer to each regulation for final reference.

8.12.1. FCC (USA)

The FCC statement should be included in the user manual when there is no enough space on label. Otherwise, it should be included on the label.

“This device complies with part 15 of the FCC rules. Operation is subject to the following two conditions. (1) This device may not cause harmful interference. (2) This device must accept any interference received, including interference that may cause undesired operation.”

The final end product must be labeled in a visible area with the following: **“Contain FCC ID: SH6AN54LQ”**.

8.12.2. TELEC (Japan)

When manufacturer is placing the product on the Japanese market, the product must be affixed with the following Specified Radio Equipment marking:



8.12.3. NCC (Taiwan)

根據 NCC LP0002 低功率射頻器材技術規範_章節 3.8.2：

- 取得審驗證明之低功率射頻器材，非經核准，公司、商號或使用者均不得擅自變更模組之頻率、加大功率或更改原設計之特性與功能。
- 低功率射頻器材之使用不得影響飛航安全及干擾合法通信；經發現有干擾現象時，應立即停用，並改善至無干擾時方得繼續使用。
- 低功率射頻器材須忍受合法通信或工業、科學及醫療用電波輻射性電機設備之干擾。

前述合法通信，係指依《電信管理法》規定作業之無線電通信。

此模組於取得認證後，將依規定於模組本體標示審驗合格標籤，並要求平台廠商於平台上標示。

請依下列標籤式樣自製標籤，標貼或印鑄於器材本體明顯處，始得販賣或公開陳列。

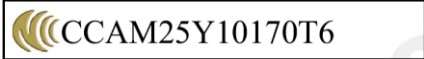
Series	標籤樣式
AN54LQ Series	
AN54LQ-P Series	
AN54LQ-U Series	

以 AN54LQ-15 為例，平台廠商必須於平台上標示字樣「本產品內含射頻模組：ID 編號 CCAM25Y10170T6」。

「平台」定義如下：若器材組裝本案模組，消費者仍能正常使用該器材主要功能，該器材得視為平台。若器材不組裝本案模組，消費者不能正常使用該器材主要功能，該器材不能視為平台。

該類不同廠牌型號器材組裝本案審驗模組後，須分別申請型式認證。

8.12.4. IC (Canada)

The IC statement should be included in the user manual when there is no enough space on label. Otherwise, it should be included on the label.

“This device complies with Industry Canada license-exempt RSS Standard(s). Operation is subject to the following two conditions. (1) This device may not cause harmful interference. (2) This device must accept any interference received, including interference that may cause undesired operation.

Le présent appareil est conforme aux CNR d'Industrie Canada applicables aux appareils radio exempts de licence. L'exploitation est autorisée aux deux conditions suivantes: (1) l'appareil ne doit pas produire de brouillage, et (2) l'utilisateur de l'appareil doit accepter tout brouillage radioélectrique subi, même si le brouillage est susceptible d'en compromettre le fonctionnement.”

The final end product must be labeled in a visible area with the following: “**Contain IC ID: 8017A-AN54LQ**”.

8.13. Compliance and Certification

8.13.1. List of Applicable FCC Rules

This module has been tested and found to comply with the following requirements for Modular Approval.

- 47 CFR Part 15 Subpart C Intentional Radiators.

8.13.2. RF Exposure Considerations

This module has been evaluated for portable RF exposure conditions and is compliant with FCC RF exposure requirements when used in portable configurations. The module is approved for use without a minimum separation distance from the user's body.

Host product manufacturers integrating this module must ensure that their final host product maintains the portable use conditions as tested and documented in the RF exposure compliance reports referenced in the RF exposure exhibit.

Configuration with multiple transmitters in the same host, routine evaluation or SAR testing for the simultaneous transmission of the co-located transmitters according to KDB 447498 is required. The portable host product shall be evaluated for ensuring to continue compliance FCC rule part 2.1093 & part 1.1310 by C2PC. The additional guidance for the portable host products is provided in KDB Publication 996369 D02 and D04.

For the host product is not installed according to this guide, the module certification will be invalid, and a new grant certification will be required for the host product.

End-user documentation shall include the RF exposure information provided below.

RF Exposure Statement:

This equipment complies with FCC radiation exposure limits set forth for an uncontrolled environment. This transmitter must not be co-located or operating in conjunction with any other antenna or transmitter. The device has been evaluated for portable operation without separation distance from the user and meets the FCC RF exposure requirements for such use.

8.13.3. Antennas

This radio transmitter has been approved by Federal Communications Commission and Innovation, Science and Economic Development Canada to operate with the antenna types listed below, with the maximum permissible gain indicated. Antenna types not included in this list that have a gain greater than the maximum gain indicated for any type listed are strictly prohibited for use with this device.

Cet émetteur radio a été approuvé par la Commission fédérale des communications et Innovation, Sciences et Développement économique Canada pour fonctionner avec les types d'antennes énumérés ci-dessous, avec le gain maximal autorisé indiqué. Les types d'antennes non mentionnés dans cette liste dont le gain est supérieur au gain maximal indiqué pour l'un des types énumérés sont strictement interdits avec cet appareil.

On board antenna

Antenna Type	Supplier	Antenna Part No.	Freq. (MHz)	Peak Antenna Gain (dBi)
Monopole	Raytac	AN54LQ	2400~2500	1.42
PIFA	Raytac	AN54LQ-P	2400~2500	0.06

External antenna

Antenna Type	Supplier	Antenna Part No.	Freq. (MHz)	Peak Antenna Gain (dBi)
Dipole	Aristotle	RFA-02-5-F17H170100B	2400~2500	5
Dipole	YAGEO	ANTX100P111B24003	2400~2500	3.3
Dipole	YAGEO	ANTX100P011B24003	2400~2500	2.2
Dipole	Pulse	ANTX100ETHAB24553	2400~2500	2.22

8.13.4. Information on Test Modes and Additional Testing Requirements

The module can be configured to continuously transmit on a specific frequency with a fixed modulation pattern. This allows evaluation of radiated emissions and spurious emissions in a controlled condition.

These test modes are intended for compliance testing only and must not be enabled during normal operation of the final product.

For more detailed information, please contact the grantee for assistance with test modes needed for module/host compliance test requirements.

8.13.5. Additional Testing, Part 15 Subpart B Disclaimer

The modular transmitter is only FCC authorized for the specific rule parts (i.e., FCC transmitter rules) listed on the grant, and that the host product manufacturer is responsible for compliance to any other FCC rules that apply to the host not covered by the modular transmitter grant of certification.

The final host product still requires Part 15 Subpart B compliance testing with the modular transmitter installed.

8.13.6. Note EMI Considerations

Note that a host manufacture is recommended to use KDB996369 D04 Module Integration Guide recommending as "best practice" RF design engineering testing and evaluation in case non-linear interactions generate additional non-compliant limits due to module placement to host components or properties.

For standalone mode, reference the guidance in KDB996369 D04 Module Integration Guide and for simultaneous mode; see KDB996369 D02 Module Q&A Question 12, which permits the host manufacturer to confirm compliance.

8.13.7. How to Make Changes

Only Grantees are permitted to make permissive changes, if the module will be used differently than granted conditions, please contact us to ensure modifications will not affect compliance.

9. Notes and Cautions

To ensure proper integration and long-term reliability of this RF module, the following regulatory and technical considerations must be observed:

The OEM integrator must not provide instructions to the end user regarding how to install or remove this RF module in the user manual of the final product that integrates this module.

The end user manual shall include all required regulatory information and warnings as shown in the official user manual.

This module is not designed for lifetime use. Like general electronic products, it may degrade after continuous usage over the years. To ensure optimal performance and longevity, please observe the following precautions:

- Follow the guidelines of this document while designing circuit/end-product. Any discrepancy of core Bluetooth technology and technical specification of IC should refer to definition of Bluetooth Organization and Nordic Semiconductor as final reference.
- Do not supply voltage that is not within range of specification.
- Eliminate static electricity at any cost when working with the module as it may cause damage. It is highly recommended adding anti-ESD components to circuit design to prevent damage from real-life ESD events. Anti-ESD methods can be also applied in mechanical design.
- Do not expose modules under direct sunlight for long duration. Modules should be kept away from humid and salty air conditions, and any corrosive gasses or substances. Store it within -40°C to $+125^{\circ}\text{C}$ before and after installation.
- Avoid any physical shock, intense stress to the module or its surface.
- Do not wash the module. No-Clean Paste is used in production. Washing it will oxidize the metal shield and have chemistry reaction with No-Clean Paste. Functions of the module are not guaranteed if it has been washed.

The module is not suitable for life support device or system and not allowed to be used in destructive device or systems in any direct or indirect ways. The customer agrees to indemnify Raytac for any losses when applying modules in applications such as the ones described above.

10. Useful links

- **Nordic Infocenter:** <https://docs.nordicsemi.com/>
All the necessary technical files and software development kits of Nordic's chip are on this website.
- **Nordic DevZone:** <https://devzone.nordicsemi.com/questions/>
A highly recommended website for firmware developer. Interact with other developers and Nordic's employees will help with your questions. The site also includes tutorials in detail to help you get started.
- **Official page of nRF54L15 :** <https://www.nordicsemi.com/Products/nRF54L15>
A brief introduction to nRF54L15 and download links for Nordic's developing software and SoftDevices.



Full list of Raytac's Wi-Fi modules

● AN7002Q series (QFN package IC)

Series	Nordic Solution	Raytac No.	IC Ver.	Antenna	Size	Weight
AN7002Q	nRF7002	AN7002Q	1	Chip Antenna	17.1 x 10.8 x 2.1 mm	0.78 (±0.02g)
		AN7002Q-P	1	PCB Antenna	17.1 x 10.8 x 2.1 mm	0.79 (±0.02g)
		AN7002Q-U	1	u.FL Connector	16.4 x 10.8 x 2.1 mm	0.85 (±0.02g)



Full list of Raytac's Bluetooth modules

● AN54LQ series (QFN package IC)

Series	Nordic Solution	Raytac No.	IC Ver.	Antenna	RAM	NVM
AN54LQ	nRF54L15	AN54LQ-15	1	Chip Antenna	256 kB	1524 KB
	nRF54L10	AN54LQ-10	1		192 kB	1012 KB
	nRF54L05	AN54LQ-05	1		96 kB	500 KB
AN54LQ-P	nRF54L15	AN54LQ-P15	1	PCB Antenna	256 kB	1524 KB
	nRF54L10	AN54LQ-P10	1		192 kB	1012 KB
	nRF54L05	AN54LQ-P05	1		96 kB	500 KB
AN54LQ-U	nRF54L15	AN54LQ-U15	1	u.FL Connector	256 kB	1524 KB
	nRF54L10	AN54LQ-U10	1		192 kB	1012 KB
	nRF54L05	AN54LQ-U05	1		96 kB	500 KB

● AN54LV series (WLCSP package IC)

Series	Nordic Solution	Raytac No.	IC Ver.	Antenna	RAM	NVM
AN54LV	nRF54L15	AN54LV-15	1	Chip Antenna	256 kB	1524 KB
AN54LV-P		AN54LV-P15	1	PCB Antenna		

● **MDBT53 series (WLCSP package IC)**

Series	Nordic Solution	Raytac No.	IC Ver.	Antenna	RAM	Flash Memory
MDBT53	nRF5340	MDBT53-1M	1	Chip Antenna	512 kB	1 MB
MDBT53-P	nRF5340	MDBT53-P1M	1	PCB Antenna	512 kB	1 MB
MDBT53-U	nRF5340	MDBT53-U1M	1	u.FL Connector	512 kB	1 MB

● **MDBT53V series (WLCSP package IC)**

Series	Nordic Solution	Raytac No.	IC Ver.	Antenna	RAM	Flash Memory
MDBT53V	nRF5340	MDBT53V-1M	1	Chip Antenna	512 kB	1 MB
MDBT53V-P	nRF5340	MDBT53V-P1M	1	PCB Antenna	512 kB	1 MB

● MDBT50 series (QFN package IC)

Series	Nordic Solution	Raytac No.	IC Ver.	Antenna	RAM	Flash Memory
MDBT50	nRF52820	MDBT50-256R	1	Chip Antenna	32 kB	256 kB
	nRF52833	MDBT50-512K	1		128 kB	512 kB
MDBT50-P	nRF52820	MDBT50-P256R	1	PCB Antenna	32 kB	256 kB
	nRF52833	MDBT50-P512K	1		128 kB	512 kB

● MDBT50Q series (aQFN package IC)

Series	Nordic Solution	Raytac No.	IC Ver.	Antenna	RAM	Flash Memory
MDBT50Q	nRF52840	MDBT50Q-1MEN	3	Chip Antenna	256 kB	1 MB
	nRF52840	MDBT50Q-1MV2	2			
	nRF52833	MDBT50Q-512K	1		128 kB	512 kB
MDBT50Q-P	nRF52840	MDBT50Q-P1MEN	3	PCB Antenna	256 kB	1 MB
	nRF52840	MDBT50Q-P1MV2	2			
	nRF52833	MDBT50Q-P512K	1		128 kB	512 kB
MDBT50Q-U	nRF52840	MDBT50Q-U1MEN	3	u.FL Connector	256 kB	1 MB
	nRF52840	MDBT50Q-U1MV2	2			
	nRF52833	MDBT50Q-U512K	1		128 kB	512 kB
Dongle	nRF52840	MDBT50Q-RX	1, 2	PCB Antenna	256 kB	1 MB
		MDBT50Q-CX-40	1			
	nRF52833	MDBT50Q-CX-33	1		128 kB	512 kB

● **MDBT42T series (WLCSP package IC)**

Series	Nordic Solution	Raytac No.	IC Ver.	Antenna	RAM	Flash Memory
MDBT42T	nRF52805	MDBT42T-192K	1	Chip Antenna	24 kB	192 kB
MDBT42T-P		MDBT42T-P192K		PCB Antenna		

● **MDBT42TV series (WLCSP package IC)**

Series	Nordic Solution	Raytac No.	IC Ver.	Antenna	RAM	Flash Memory
MDBT42TV	nRF52805	MDBT42TV-192K	1	Chip Antenna	24 kB	192 kB
MDBT42TV-P		MDBT42TV-P192K		PCB Antenna		

● **MDBT42 series (WLCSP package IC)**

Series	Nordic Solution	Raytac No.	IC Ver.	Antenna	RAM	Flash Memory
MDBT42	nRF52832	MDBT42-512KV2	2	Chip Antenna	64 kB	512 kB
MDBT42-P		MDBT42-P512KV2		PCB Antenna		

● **MDBT42V series (WLCSP package IC)**

Series	Nordic Solution	Raytac No.	IC Ver.	Antenna	RAM	Flash Memory
MDBT42V	nRF52832	MDBT42V-512KV2	2	Chip Antenna	64 kB	512 kB
MDBT42V-P		MDBT42V-P512KV2		PCB Antenna		

● MDBT42Q series (QFN package IC)

Series	Nordic Solution	Raytac No.	IC Ver.	Antenna	RAM	Flash Memory
MDBT42Q	nRF52832	MDBT42Q-512KEN	3	Chip Antenna	64 kB	512 kB
	nRF52832	MDBT42Q-512KV2	2			
	nRF52810	MDBT42Q-192KV2	2		24 kB	192 kB
	nRF52811	MDBT42Q-192KL	1			
MDBT42Q-P	nRF52832	MDBT42Q-P512KEN	3	PCB Antenna	64 kB	512 kB
	nRF52832	MDBT42Q-P512KV2	2			
	nRF52810	MDBT42Q-P192KV2	2		24 kB	192 kB
	nRF52811	MDBT42Q-P192KL	1			
MDBT42Q-U	nRF52832	MDBT42Q-U512KEN	3	u.FL Connector	64 kB	512 kB
	nRF52832	MDBT42Q-U512KV2	2			

● MDBT40 series

Series	Nordic Solution	Raytac No.	IC Ver.	Antenna	RAM	Flash Memory
MDBT40	nRF51822	MDBT40-256V3	3	Chip Antenna	16 kB	256 kB
		MDBT40-256RV3			32 kB	256 kB
MDBT40-P	nRF51822	MDBT40-P256V3	3	PCB Antenna	16 kB	256 kB
		MDBT40-P256RV3			32 kB	256 kB

Release Note

- 2025/11/05 Version 1.0: 1st release.

