

# Data Sheet

## (規格書)

產品名稱 (Product)	<b>Bluetooth Low Energy Module</b>
解決方案 (Solution)	<b>Nordic nRF54L15 WLCSP Package</b>
產品型號 (Model No.)	<b>AN54LV-K15 (Pin Antenna)</b>
產品料號 (Part No.)	See <a href="#">4.3 Order code</a>

Model	Working distance (in Meters)			Operating Temperature
	125 Kbps	1 Mbps	2 Mbps	
AN54LV-15	over 500	over 350	over 200	-40 ~ 105°C
AN54LV-P15	over 450	over 350	over 200	-40 ~ 105°C
AN54LV-U15	over 550	over 400	over 200	-40 ~ 85°C
AN54LV-K15	over 450	over 350	over 200	-40 ~ 105°C

*Working range is tested in open space*

# Index

<b>1. Overall introduction</b>	<b>4</b>
1.1. Application	4
1.2. Features	5
<b>2. Product dimension</b>	<b>6</b>
2.1. PCB dimensions & pin Indication	6
2.2. Recommended layout of solder pad	7
2.3. RF layout suggestion (AKA, antenna keep-out area)	9
2.4. Footprint & design guide	11
2.5. Pin assignment	12
<b>3. Main chip solution</b>	<b>17</b>
<b>4. Shipment packaging information</b>	<b>18</b>
4.1. Marking on metal shield	19
4.2. Packaging info	19
4.2.1. Tray packaging	19
4.3. Order code	20
<b>5. Specification</b>	<b>21</b>
5.1. Recommended operating conditions	21
5.2. Radio specifications	21
5.2.1. General radio characteristics	21
5.2.2. Radio current consumption (Transmitter)	22
5.2.3. Radio current consumption (Receiver)	22
5.2.4. Transmitter specification	22
5.2.5. Receiver operation	23
5.2.6. RX selectivity	24
5.2.7. RX intermodulation	25
5.2.8. Radio timing parameters	26
5.2.9. RSSI specifications	27
5.3. GPIO electrical specification	28
5.4. Absolute maximum ratings	29
<b>6. Block diagram</b>	<b>30</b>
<b>7. Reference circuit</b>	<b>31</b>
<b>8. Certification</b>	<b>32</b>
8.1. Declaration ID for Bluetooth	32
8.2. FCC Certificate (USA)	33

8.3.	TELEC Certificate (Japan).....	36
8.4.	NCC Certificate (Taiwan) .....	37
8.5.	CE (EU) & RCM (Australia & New Zealand) test report.....	41
8.6.	IC Certificate (Canada).....	49
8.7.	SRRC Certificate (China).....	50
8.8.	KC Certificate (South Korea) .....	52
8.9.	EU and UKCA Declarations of Conformity .....	53
8.10.	RoHS & REACH report.....	53
8.11.	End-product label .....	53
8.11.1.	FCC (USA).....	54
8.11.2.	TELEC (Japan) .....	54
8.11.3.	NCC (Taiwan).....	54
8.11.4.	IC (Canada) .....	55
8.12.	Compliance and Certification.....	56
8.12.1.	List of Applicable FCC Rules .....	56
8.12.2.	RF Exposure Considerations .....	56
8.12.3.	Antennas.....	57
8.12.4.	Information on Test Modes and Additional Testing Requirements .....	58
8.12.5.	Additional Testing, Part 15 Subpart B Disclaimer .....	58
8.12.6.	Note EMI Considerations .....	58
8.13.	How to Make Changes .....	59
<b>9.</b>	<b>Notes and Cautions.....</b>	<b>60</b>
<b>10.</b>	<b>Useful links .....</b>	<b>61</b>
	<b>Full list of Raytac’s WiFi modules.....</b>	<b>62</b>
	<b>Full list of Raytac’s Bluetooth modules.....</b>	<b>63</b>
	<b>Release Note .....</b>	<b>68</b>

# 1. Overall introduction

Raytac's AN54LV family us a Bluetooth® 6.0 stack (Bluetooth low energy or BLE) modules designed based on **Nordic nRF54L15 SoC solution**, which incorporates: **GPIO, QSPI (emulated), SPI, UART, I2C, I2S, PDM, PWM, ADC** and **NFC** interfaces for connecting peripherals and sensors.

Product Character:

1. MCU (Microcontroller Unit) featuring a 128 MHz Arm Cortex-M33 processor.
2. Embedded **1524 KB** NVM and up to **256 KB** RAM.
3. An integrated RISC-V coprocessor.
4. The multiprotocol 2.4 GHz radio modes are supported based on customer preference.
5. Compact size with **(L) 8.4 x (W) 6.4 x (H) 1.5mm**
6. Wide supply voltage range **1.7V to 3.6V**.
7. Operation temperature from **-40°C to 105°C**.
8. Up to **32** GPIOs.

## 1.1. Application

- IoT
  - Smart home sensors and actuators
  - Industrial sensors and actuators
  - Gateways and hubs
- Advanced computer peripherals and I/O devices
  - Keyboard
  - Mouse
  - Stylus
- Interactive entertainment devices
  - Remote controls
  - Gaming controllers
- Safety and security
  - Access control
  - Asset tracking
- Wearable health and fitness monitoring
- Lighting control

## 1.2. Features

- Multi-protocol 2.4GHz radio
- 128MHz Arm Cortex-M33 with Thumb-2 (16/32-bit instruction set)
- 1524KB flash programmed memory and 256KB RAM
- 128-bit AES / ECB / CCM / AAR co-processor
- Up to +8 dBm configurable output power
- RSSI (1dB resolution)

### Peripherals

- 128 MHz RISC-V coprocessor which is a fast, lightweight peripheral processor (FLPR)
- Timer counter
  - 7 x 32-bit
  - 2 x 24-bit RTC
- Fully featured serial interface with EasyDMA support including:
  - One high-speed SPIM up to 32 MHz, four SPI to 8 MHz
  - One high-speed UARTE up to 4 Mbps, four UART to 1 Mbps
  - I<sup>2</sup>C up to 400 kHz
- Three pulse width modulator (PWM) units with EasyDMA
- I<sup>2</sup>S two channel Inter-IC sound interface
- ADC with up to eight programmable gain channels.
- Pulse density modulation (PDM) interface
- Near field communication (NFC)
- Quadrature decoders(QDEC)
- Temperature sensor

## 2. Product dimension

### 2.1. PCB dimensions & pin Indication

- **AN54LV-K15**

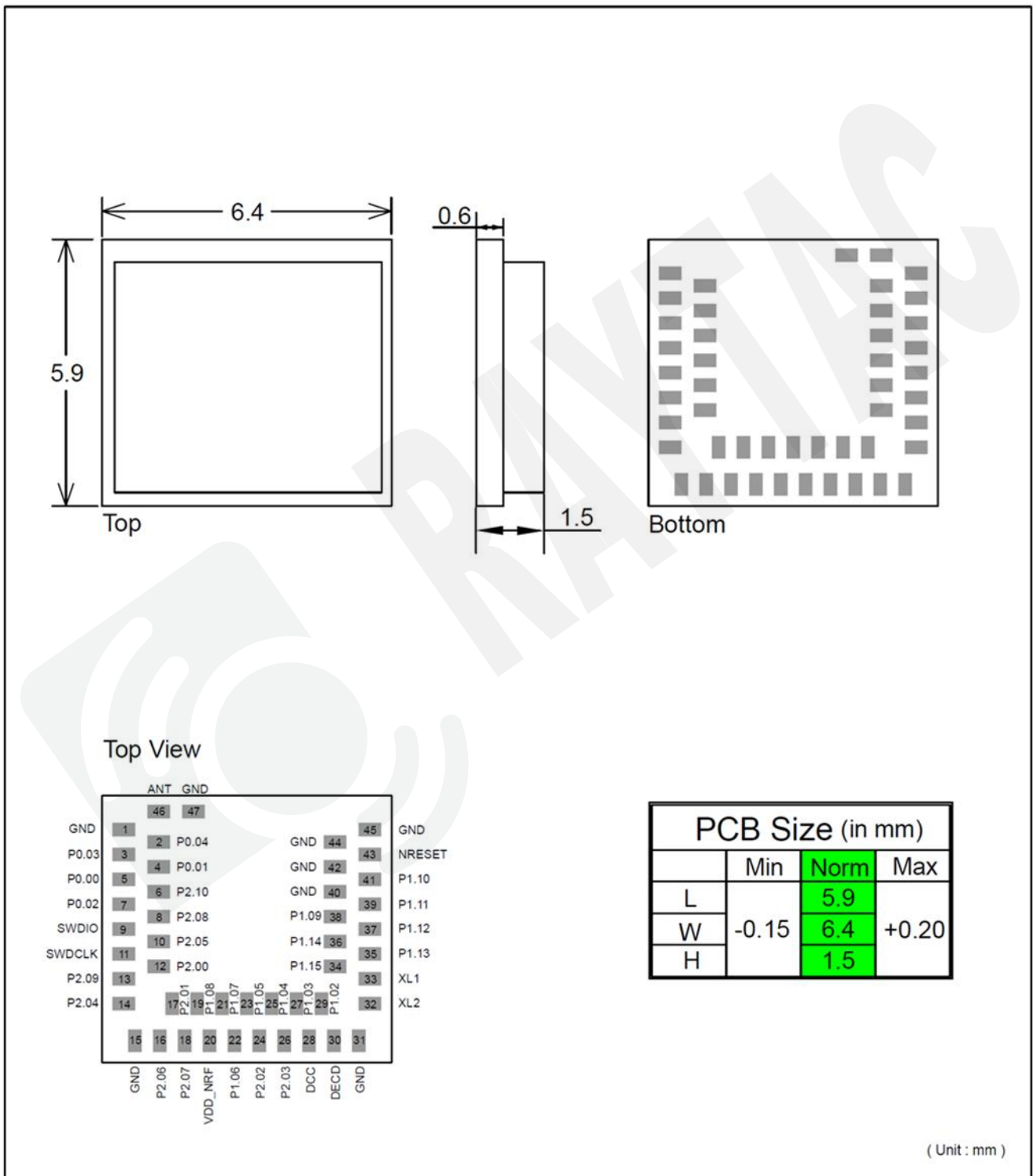

## 2.2. Recommended layout of solder pad

*Graphs are all in Top View, Unit in mm.*

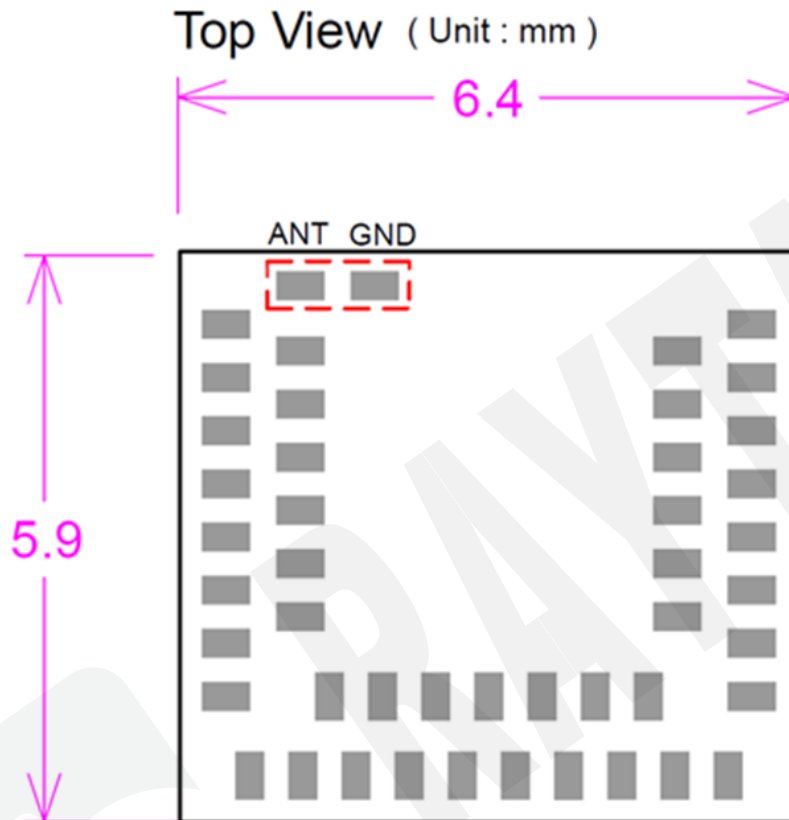

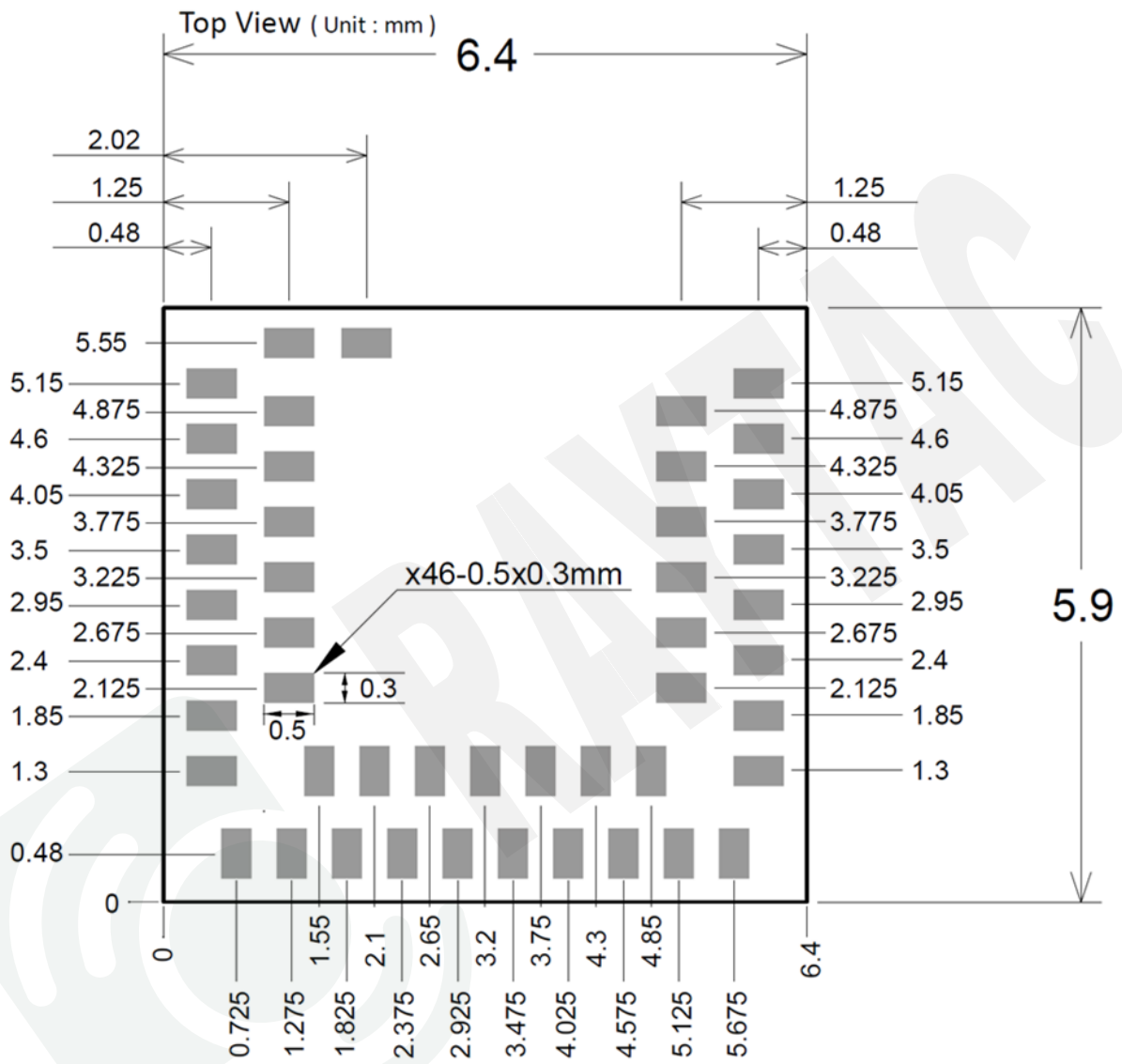

### 2.3. RF layout suggestion (AKA, antenna keep-out area)

Please ensure that no ground pad overlaps the “No Ground-Pad Area”, as shown in the images below. This is important to maintain antenna performance and to prevent potential short circuits within the module.

You are welcome to send us your design files for review at [sales@raytac.com](mailto:sales@raytac.com) or to your Raytac contact with email subject titled: “Layout Review – Raytac Model No. – Your company name”.

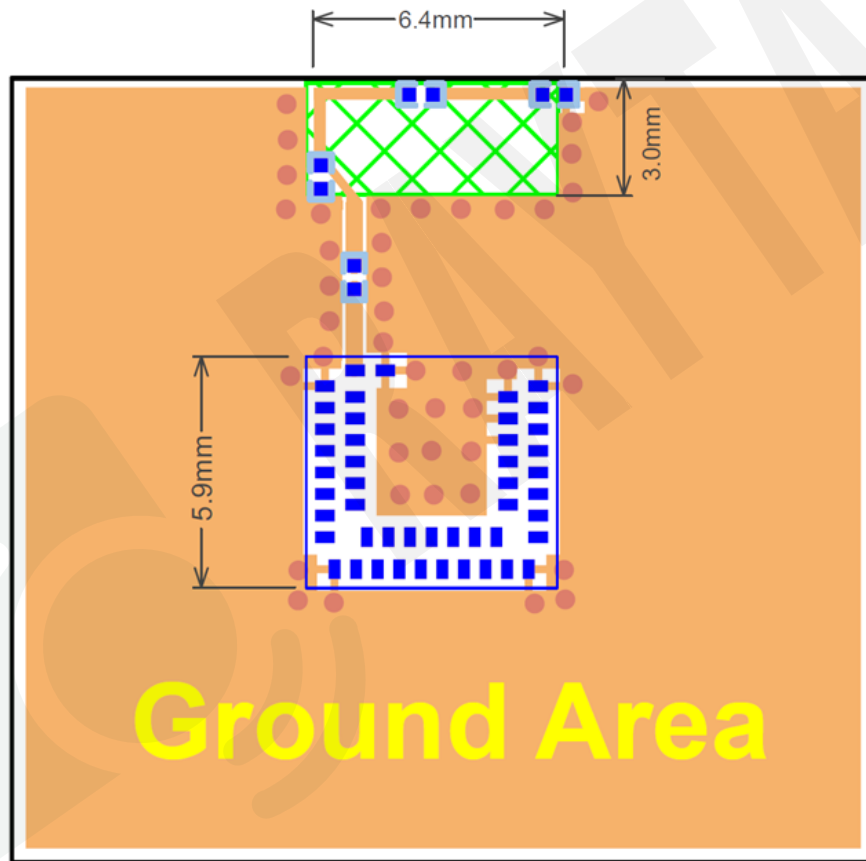

Top View

 No Ground Pad Area

Please add via holes in GROUND area as many as possible, especially around the four corners.

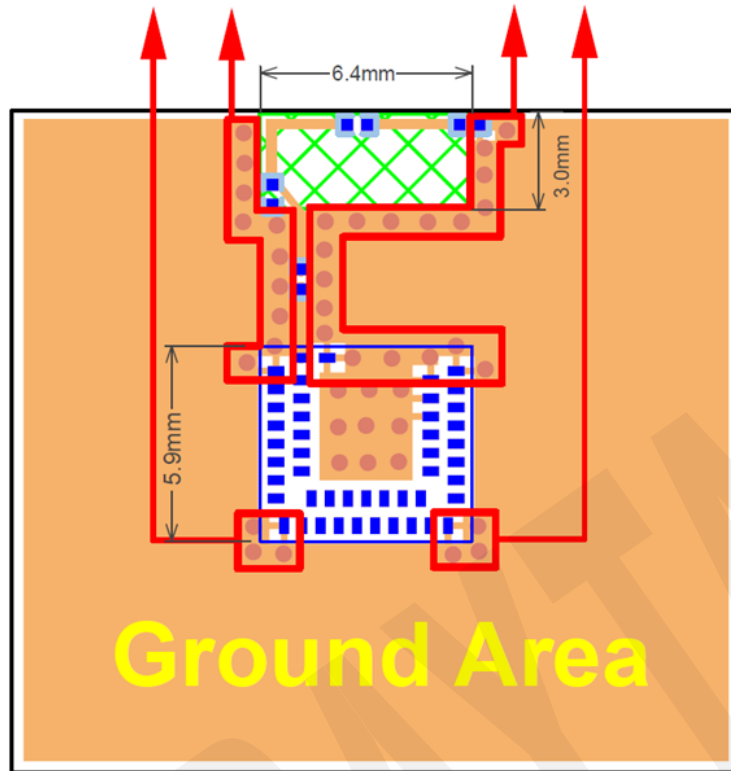

Top View

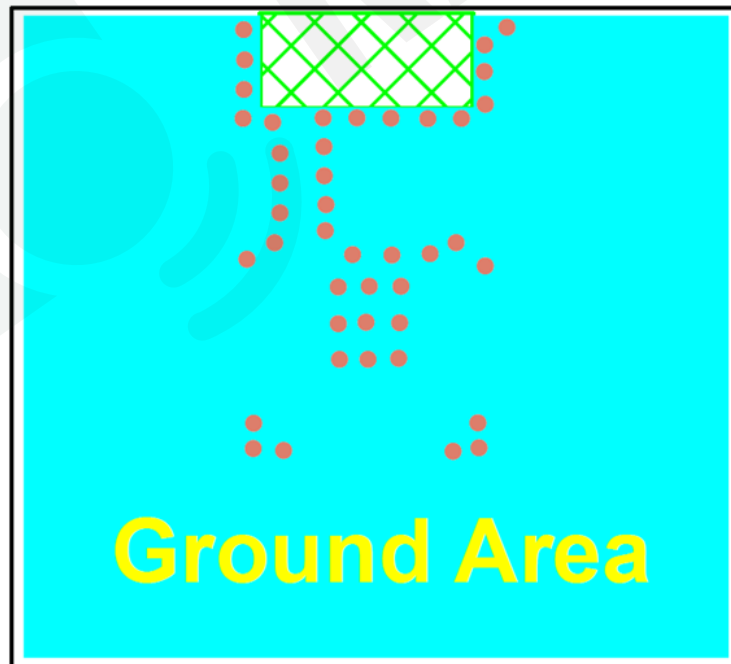

Perspective View

 No Ground Pad Area

## 2.4. Footprint & design guide

Please visit "[Support](#)" page of our website to download. The package includes footprint, 2D/3D drawing, and reflow graph/solder profile.



## 2.5. Pin assignment

Pin	Name	Pin function	Description
(1)	<b>GND</b>	Ground	The pad must be connected to a solid ground plane
(2)	<b>P0.04</b>	Digital I/O	General-purpose digital I/O
		Digital I/O	GRTC CLKOUT32K
(3)	<b>P0.03</b>	Digital I/O	General-purpose digital I/O
		Digital I/O	GRTC PWM
(4)	<b>P0.01</b>	Digital I/O	General-purpose digital I/O
(5)	<b>P0.00</b>	Digital I/O	General-purpose digital I/O
		<b>P2.10</b>	Digital I/O
(6)	<b>TRACEDATA [3]</b>	Digital I/O	FLPR.10
		Digital I/O	Trace data
		Digital I/O	SPIM CSN
		Digital I/O	SPIS CSN
(7)	<b>P0.02</b>	Digital I/O	UARTE RTS
		Digital I/O	General-purpose digital I/O
(8)	<b>P2.08</b>	Digital I/O	General-purpose digital I/O
		Digital I/O	FLPR.8
		Digital I/O	Trace data
		Digital I/O	SPIM SDO
		Digital I/O	SPIS SDO
(9)	<b>SWDIO</b>	Digital I/O	UARTE TXD
		Digital I/O	Serial Wire debug I/O for debug and programming
		Digital I/O	General-purpose digital I/O
		Digital I/O	SPIM CSN
(10)	<b>P2.05</b>	Digital I/O	SPIS CSN
		Digital I/O	UARTE RTS
		Digital I/O	FLPR.5
		Digital I/O	QSPI CSN
(11)	<b>SWDCLK</b>	Digital input	Serial Wire debug clock input for debug and programming

Pin	Name	Pin function	Description		
(12)	P2.00	Digital I/O	General-purpose digital I/O		
		Digital I/O	SPIM DCX		
		Digital I/O	UARTE RXD		
		Digital I/O	FLPR.4		
		Digital I/O	QSPI D3		
(13)	P2.09 TRACEDATA [2]	Digital I/O	General-purpose digital I/O		
		Digital I/O	FLPR.9		
		Digital I/O	Trace data		
		Digital I/O	SPIM SDI		
		Digital I/O	SPIS SDI		
(14)	P2.04	Digital I/O	UARTE CTS		
		Digital I/O	General-purpose digital I/O		
		Digital I/O	SPIM SDI		
		Digital I/O	SPIS SDI		
		Digital I/O	UARTE CTS		
(15)	GND	Ground	The pad must be connected to a solid ground plane		
		(16)	P2.06 TRACECLK	Digital I/O	General-purpose digital I/O
				Digital I/O	FLPR.6
				Digital I/O	SPIM SCK
				Digital I/O	SPIS SCK
Digital I/O	Trace clock				
(17)	P2.01	Digital I/O	General-purpose digital I/O		
		Digital I/O	SPIM SCK		
		Digital I/O	SPIS SCK		
		Digital I/O	FLPR.0		
		Digital I/O	QSPI SCK		

Pin	Name	Pin function	Description
(18)	P2.07	Digital I/O	General-purpose digital I/O
		Digital I/O	FLPR.7
	TRACEDATA [0]	Digital I/O	Trace data
	SWO	Digital I/O	Serial wire output (SWO)
		Digital I/O	SPIM DCX
		Digital I/O	UARTE RXD
(19)	P1.08	Digital I/O	General-purpose digital I/O
		Digital I/O	GRTC CLKOUTFAST
	EXTREF	Analog input	External reference for SAADC
(20)	VDD_NRF	Power	Power-supply pin
(21)	P1.07	Digital I/O	General-purpose digital I/O
	AIN3	Analog input	SAADC input
	ASI [1]	Digital I/O	TAMPC active shield 1 input
(22)	P1.06	Digital I/O	General-purpose digital I/O
		AIN2	Analog input
	ASO [1]	Digital I/O	TAMPC active shield 1 output
(23)	P1.05	Digital I/O	General-purpose digital I/O
	AIN1	Analog input	SAADC input
	ASI [0]	Digital I/O	TAMPC active shield 0 input
	RADIO [6]	Digital I/O	RADIO DFEGPIO
(24)	P2.02	Digital I/O	General-purpose digital I/O
		Digital I/O	SPIM SDO
		Digital I/O	SPIS SDO
		Digital I/O	UARTE TXD
		Digital I/O	FLPR.1
		Digital I/O	QSPI D0
(25)	P1.04	Digital I/O	General-purpose digital I/O
	AIN0	Analog input	SAADC input
	ASO [0]	Digital I/O	TAMPC active shield 0 output
(26)	P2.03	Digital I/O	General-purpose digital I/O
		Digital I/O	FLPR.3
		Digital I/O	QSPI D2

Pin	Name	Pin function	Description
(27)	P1.03	Digital I/O	General-purpose digital I/O
	NFC2	NFC input	NFC antenna connection
(28)	DCC	Power	DC/DC converter output pin
(29)	P1.02	Digital I/O	General-purpose digital I/O
	NFC1	NFC input	NFC antenna connection
(30)	DECD	Digital I/O	0.9 V regulator supply decoupling
(31)	GND	Ground	The pad must be connected to a solid ground plane
(32)	P1.01	Digital I/O	General-purpose digital I/O
	XL2	Analog input	Connection to 32.768khz crystal (LFXO)
(33)	P1.00	Digital I/O	General-purpose digital I/O
	XL1	Analog input	Connection to 32.768khz crystal (LFXO)
(34)	P1.15	Digital I/O	General-purpose digital I/O
(35)	P1.13	Digital I/O	General-purpose digital I/O
	AIN6	Analog input	SAADC input
	RADIO [4]	Digital I/O	RADIO DFEGPIO
(36)	P1.14	Digital I/O	General-purpose digital I/O
	AIN7	Analog input	SAADC input
	RADIO [5]	Digital I/O	RADIO DFEGPIO
(37)	P1.12	Digital I/O	General-purpose digital I/O
	AIN5	Analog input	SAADC input
	ASI [3]	Digital I/O	TAMPC active shield 3 input
	RADIO [3]	Digital I/O	RADIO DFEGPIO
(38)	P1.09	Digital I/O	General-purpose digital I/O
	ASO [2]	Digital I/O	TAMPC active shield 2 output
	RADIO [0]	Digital I/O	RADIO DFEGPIO
(39)	P1.11	Digital I/O	General-purpose digital I/O
	AIN4	Analog input	SAADC input
	ASO [3]	Digital I/O	TAMPC active shield 3 output
	RADIO [2]	Digital I/O	RADIO DFEGPIO
(40)	GND	Ground	The pad must be connected to a solid ground plane

Pin	Name	Pin function	Description
	<b>P1.10</b>	Digital I/O	General-purpose digital I/O
(41)	<b>ASI [2]</b>	Digital I/O	TAMPC active shield 2 input
	<b>RADIO [1]</b>	Digital I/O	RADIO DFEGPIO
(42)	<b>GND</b>	Ground	The pad must be connected to a solid ground plane
(43)	<b>NRESET</b>	Reset	Configurable as system RESET pin
(44)	<b>GND</b>	Ground	The pad must be connected to a solid ground plane
(45)	<b>GND</b>	Ground	The pad must be connected to a solid ground plane
(46)	<b>ANT</b>	Antenna	RF pin (Only for AN54LV-K15 Model)
(47)	<b>GND</b>	Ground	The pad must be connected to a solid ground plane (Only for AN54LV-K15 Model)



### 3. Main chip solution

RF IC	Crystal Frequency
Nordic NRF54L15 / WLCSP	32MHz

*32MHz crystal is already inside the module. The module does NOT include external capacitor for 32MHz crystal. No XOSC32M trim adjustment is required, as this has been fully handled and validated in the hardware design.*

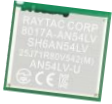

## 4. Shipment packaging information

Model	Antenna	Photo
AN54LV-15	Chip/Ceramic	
AN54LV-P15	PCB/Printed	
AN54LV-U15	U.FL/Connector	
AN54LV-K15	Antenna Pin	

- Unit weight of module:

AN54LV-15 : 0.18 g ( $\pm 0.02$  g) ; AN54LV-P15 : 0.15 g ( $\pm 0.02$  g) ; AN54LV-U15 : 0.19 g ( $\pm 0.02$  g) ;  
 AN54LV-K15 : 0.15 g ( $\pm 0.02$  g) ;

- Packaging type: Tray.

Tray	
MPQ (Min. Package Q'ty)	160 pcs per tray
Carton Contents (per carton)	3,200 pcs
Carton Dimension (L) x (W) x (H) cm	37 x 21 x 13
Gross Weight	about 2.2 kgs

## 4.1. Marking on metal shield

Label context on metal shield is as below:



## 4.2. Packaging info

### 4.2.1. Tray packaging

Anti-static tray is specifically designed for mass production. It can be used directly on SMT automatic machine.

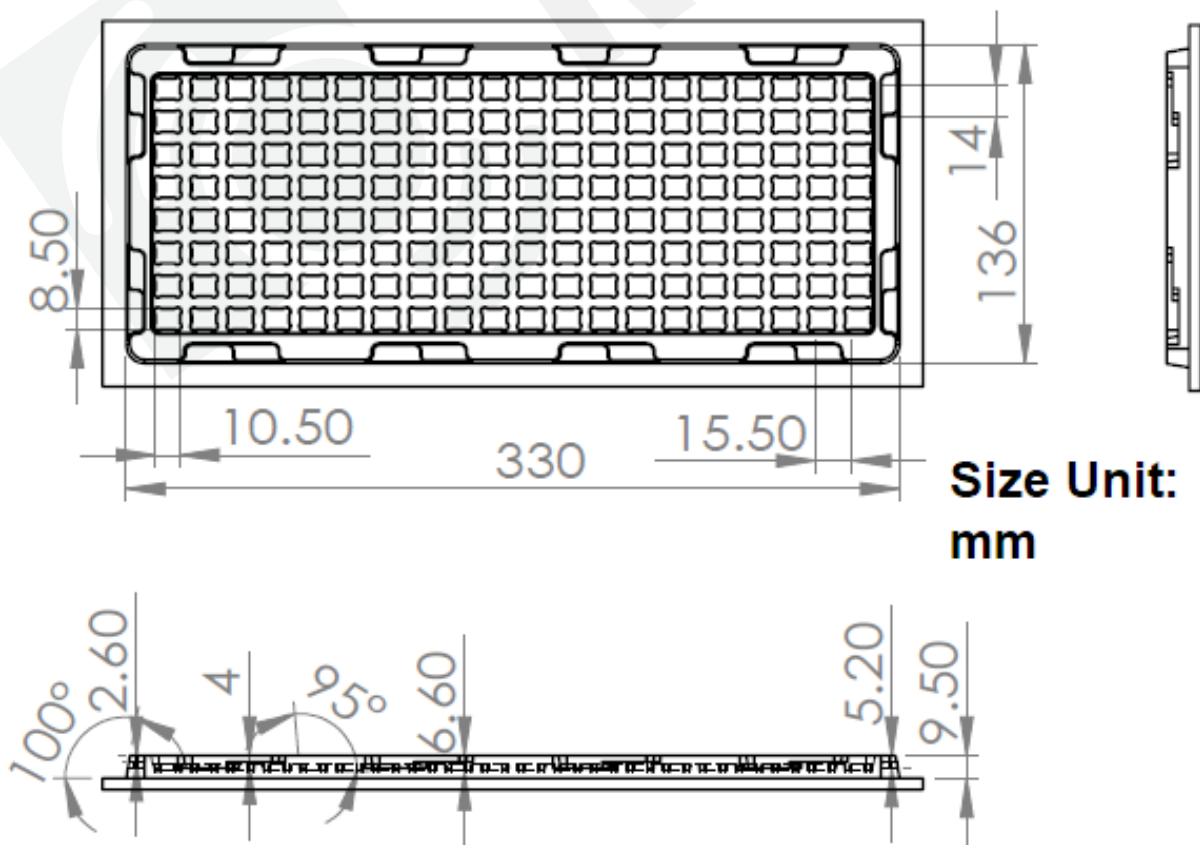

### 4.3. Order code

Each model has two options of packaging. Please use following part no. when placing order to us.

<b>Model</b>	<b>Tray</b>
AN54LV-15	MD-240A8-007
AN54LV-P15	MD-240A8-008
AN54LV-U15	MD-240A8-021
AN54LV-K15	MD-240A8-022

***MPQ of Tray packaging is 160 pcs.***

## 5. Specification

Any technical spec shall refer to Nordic's official documents as final reference. Contents below are from "[nRF54L15 Product Specification v1.0](#)", please click to download full spec.

### 5.1. Recommended operating conditions

Symbol	Parameter	Min.	Nom.	Max.	Units
VDD	VDD supply voltage	1.7		3.6	V
VDD <sub>EXT</sub>	VDD supply voltage under extended operating temperature	1.7		3.4	V
VDD <sub>POR</sub>	VDD supply voltage needed during power-on reset	1.75			V
TA	Operating temperature	-40	25	85	°C
TA <sub>EXT</sub>	Extended operating temperature	85		105	°C
T <sub>RST</sub>	Recommended storage temperature			40	°C
RH <sub>RST</sub>	Recommended storage relative humidity			90	%

The operating conditions are the physical parameters that the device can operate within.

### 5.2. Radio specifications

#### 5.2.1. General radio characteristics

Symbol	Parameter	Min.	Typ.	Max.	Units
f <sub>OP</sub>	Operating frequencies	2400		2500	MHz
f <sub>CH,SP</sub>	Channel spacing		1.0		MHz
f <sub>DELTA,1M</sub>	Frequency deviation @ 1 Mbps		± 160		kHz
f <sub>DELTA,BLE,1M</sub>	Frequency deviation @ Bluetooth LE 1 Mbps		±250		kHz
f <sub>DELTA,2M</sub>	Frequency deviation @ 2 Mbps		±320		kHz
f <sub>DELTA,BLE,2M</sub>	Frequency deviation @ Bluetooth LE 2 Mbps		±500		kHz
f <sub>DELTA,4M</sub>	Frequency deviation @ 4 Mbps		±1000		kHz
Fsk <sub>BPS</sub>	On-the-air data rate	125		4000	kbps
f <sub>chip, IEEE 802.15.4</sub>	Chip rate in IEEE 802.15.4 mode		2000		kchip/s

## 5.2.2. Radio current consumption (Transmitter)

Symbol	Description	Min.	Typ.	Max.	Units
$I_{TX,MaxdBm,QFN}$	TX only run current for QFN package, $P_{RF}$ at maximum power setting		9.1		mA
$I_{TX,MaxdBm,csp}$	TX only run current for CSP package, $P_{RF}$ at maximum power setting		9.7		mA
$I_{TX,0dBm}$	TX only run current, $P_{RF} = 0$ dBm		3.7		mA
$I_{TX,MINUS4dBm}$	TX only run current, $P_{RF} = -4$ dBm		2.8		mA
$I_{TX,MINUS8dBm}$	TX only run current, $P_{RF} = -8$ dBm		2.2		mA
$I_{TX,MINUS12dBm}$	TX only run current $P_{RF} = -12$ dBm		1.9		mA
$I_{TX,MINUS16dBm}$	TX only run current $P_{RF} = -16$ dBm		1.7		mA
$I_{TX,MINUS40dBm}$	TX only run current $P_{RF} = -40$ dBm		1.2		mA

## 5.2.3. Radio current consumption (Receiver)

Symbol	Description	Min.	Typ.	Max.	Units
$I_{RX,1M}$	RX only run current, 1 Mbps/1 Mbps Bluetooth LE mode		2.1		mA
$I_{RX,2M}$	RX only run current, 2 Mbps/2 Mbps Bluetooth LE mode		2.1		mA
$I_{START,RX,1M}$	RX start-up current, 1 Mbps/1 Mbps Bluetooth LE mode		1.6		mA

## 5.2.4. Transmitter specification

Symbol	Description	Min.	Typ.	Max.	Units
$P_{RF,QFN}$	Maximum output power for QFN package		7		dBm
$P_{RF,CSP}$	Maximum output power for CSP package		8		dBm
$P_{RFCR}$	RF power accuracy	-2		2	dB
$P_{RF1,BLE1M,2MHz}$	Adjacent Channel Transmit Power 2 MHz (1 Mbps Bluetooth LE mode)		-48		dBc
$P_{RF1,BLE1M,3MHz}$	Adjacent Channel Transmit Power 3 MHz (1 Mbps Bluetooth LE mode)		-54		dBc
$P_{RF1,BLE2M,4MHz}$	Adjacent Channel Transmit Power 4 MHz (2 Mbps Bluetooth LE mode)		-51		dBc
$P_{RF1,BLE2M,6MHz}$	Adjacent Channel Transmit Power 6 MHz (2 Mbps Bluetooth LE mode)		-56		dBc
$E_{vm}$	Error vector magnitude in IEEE 802.15.4 mode		2		%rms
$P_{harm2nd, IEEE 802.15.4}$	2nd harmonics in IEEE 802.15.4 mode		-63		dBm
$P_{harm3rd, IEEE 802.15.4}$	3rd harmonics in IEEE 802.15.4 mode		-68		dBm

## 5.2.5. Receiver operation

Symbol	Description	Min.	Typ.	Max.	Units
P <sub>RX,MAX</sub>	Maximum received signal strength at < 0.1% PER		0		dBm
P <sub>SENS,IT,1M</sub>	Sensitivity, 1 Mbps nRF mode ideal transmitter <sup>4</sup>		-93		dBm
P <sub>SENS,IT,2M</sub>	Sensitivity, 2 Mbps nRF mode ideal transmitter <sup>4</sup>		-90		dBm
P <sub>SENS,IT,4M</sub>	Sensitivity, 4 Mbps nRF mode ideal transmitter <sup>4</sup>		-90		dBm
P <sub>SENS,IT,SP,1M,BLE</sub>	Sensitivity, 1 Mbps Bluetooth LE ideal transmitter, packet length ≤ 37 bytes BER = 1E-3 <sup>5</sup>		-96 <sup>6</sup>		dBm
P <sub>SENS,IT,LP,IM,BLE</sub>	Sensitivity, 1 Mbps Bluetooth LE ideal transmitter, packet length ≥ 128 bytes BER = 1E-4		-95		dBm
P <sub>SENS,IT,SP,2M,BLE</sub>	Sensitivity, 2 Mbps Bluetooth LE ideal transmitter, packet length ≤ 37 bytes		-94		dBm
P <sub>SENS,IT,BLE LE125k</sub>	Sensitivity, 125 kbps Bluetooth LE mode		-104		dBm
P <sub>SENS,IT,BLE LE500k</sub>	Sensitivity, 500 kbps Bluetooth LE mode		-99		dBm
P <sub>SENS,IEEE 802.15.4</sub>	Sensitivity in IEEE 802.15.4 mode		-102		dBm

<sup>4</sup> Typical sensitivity applies when RXADDRESS.ADDRO is used for receiver address. When RXADDRESS.ADDR[1 ... 7] are used for receiver address, the typical sensitivity for this mode is degraded by 3 dB.

<sup>5</sup> As defined in the Bluetooth Core Specification v4.0 Volume 6: Core System Package (Low Energy Controller Volume).

<sup>6</sup> QFN package sensitivity is degraded by approximately 1 dB compared to the provided value.

## 5.2.6. RX selectivity

Symbol	Description	Min.	Typ.	Max.	Units
$C/I_{1M,co-channel}$	1 Mbps mode, co-channel interference		9		dB
$C/I_{1M,-1MHz}$	1 Mbps mode, Adjacent (-1 MHz) interference		-4		dB
$C/I_{1M,+1MHz}$	1 Mbps mode, Adjacent (+1 MHz) interference		-9		dB
$C/I_{1M,-2MHz}$	1 Mbps mode, Adjacent (-2 MHz) interference		-28		dB
$C/I_{1M,+2MHz}$	1 Mbps mode, Adjacent (+2 MHz) interference		-40		dB
$C/I_{1M,-3MHz}$	1 Mbps mode, Adjacent (-3 MHz) interference		-39		dB
$C/I_{1M,+3MHz}$	1 Mbps mode, Adjacent (+3 MHz) interference		-43		dB
$C/I_{1M,\pm 6MHz}$	1 Mbps mode, Adjacent ( $\geq 6$ MHz) interference		-48		dB
$C/I_{1MBLE,co-channel}$	1 Mbps Bluetooth LE mode, co-channel interference		6		dB
$C/I_{1MBLE,-1MHz}$	1 Mbps Bluetooth LE mode, Adjacent (-1 MHz) interference		-2		dB
$C/I_{1MBLE,+1MHz}$	1 Mbps Bluetooth LE mode, Adjacent (+1 MHz) interference		-6		dB
$C/I_{1MBLE,-2MHz}$	1 Mbps Bluetooth LE mode, Adjacent (-2 MHz) interference		-29		dB
$C/I_{1MBLE,+2MHz}$	1 Mbps Bluetooth LE mode, Adjacent (+2 MHz) interference		-43		dB
$C/I_{1MBLE,>3MHz}$	1 Mbps Bluetooth LE mode, Adjacent ( $\geq 3$ MHz) interference		-46		dB
$C/I_{1MBLE,image}$	Image frequency interference		-29		dB
$C/I_{1MBLE,image,1MHz}$	Adjacent (1 MHz) interference to in-band image frequency		-39		dB
$C/I_{2M,co-channel}$	2 Mbps mode, co-channel interference		10		dB
$C/I_{2M,-2MHz}$	2 Mbps mode, Adjacent (-2 MHz) interference		-5		dB
$C/I_{2M,+2MHz}$	2 Mbps mode, Adjacent (+2 MHz) interference		-9		dB
$C/I_{2M,-4MHz}$	2 Mbps mode, Adjacent (-4 MHz) interference		-27		dB
$C/I_{2M,+4MHz}$	2 Mbps mode, Adjacent (+4 MHz) interference		-42		dB
$C/I_{2M,-6MHz}$	2 Mbps mode, Adjacent (-6 MHz) interference		-38		dB
$C/I_{2M,+6MHz}$	2 Mbps mode, Adjacent (+6 MHz) interference		-45		dB
$C/I_{2M,\geq 12MHz}$	2 Mbps mode, Adjacent ( $\geq 12$ MHz) interference		-50		dB
$C/I_{2MBLE,co-channel}$	2 Mbps Bluetooth LE mode, co-channel interference		6		dB
$C/I_{2MBLE,-2MHz}$	2 Mbps Bluetooth LE mode, Adjacent (-2 MHz) interference		-2		dB
$C/I_{2MBLE,+2MHz}$	2 Mbps Bluetooth LE mode, Adjacent (+2 MHz) interference		-6		dB
$C/I_{2MBLE,-4MHz}$	2 Mbps Bluetooth LE mode, Adjacent (-4 MHz) interference		-29		dB
$C/I_{2MBLE,+4MHz}$	2 Mbps Bluetooth LE mode, Adjacent (+4 MHz) interference		-44		dB
$C/I_{2MBLE,\geq 6MHz}$	2 Mbps Bluetooth LE mode, Adjacent ( $\geq 6$ MHz) interference		-46		dB
$C/I_{4M,co-channel}$	4 Mbps mode, co-channel interference		6		dB
$C/I_{4M,-4MHz}$	4 Mbps mode, Adjacent (-4 MHz) interference		-4		dB
$C/I_{4M,+4MHz}$	4 Mbps mode, Adjacent (+4 MHz) interference		-11		dB
$C/I_{4M,-8MHz}$	4 Mbps mode, Adjacent (-8 MHz) interference		-27		dB
$C/I_{4M,+8MHz}$	4 Mbps mode, Adjacent (+8 MHz) interference		-46		dB

Symbol	Description	Min.	Typ.	Max.	Units
$C/I_{4M,-12MHz}$	4 Mbps mode, Adjacent (-12 MHz) interference		-40		dB
$C/I_{4M,+12MHz}$	4 Mbps mode, Adjacent (+12 MHz) interference		-50		dB
$C/I_{4M\geq 24MHz}$	4 Mbps mode, Adjacent ( $\geq 24$ MHz) interference		-56		dB
$C/I_{2MBLE,image}$	Image frequency interference		-29		dB
$C/I_{2MBLE,image,2MHz}$	Adjacent (2 MHz) interference to in-band image frequency		-38		dB
$C/I_{125k BLE LR,co-channel}$	125 kbps Bluetooth LE LR mode, co-channel interference		1		dB
$C/I_{125k BLE LR,-1MHz}$	125 kbps Bluetooth LE LR mode, Adjacent (-1 MHz) interference		-13		dB
$C/I_{125k BLE LR,+1MHz}$	125 kbps Bluetooth LE LR mode, Adjacent (+1 MHz) interference		-16		dB
$C/I_{125k BLE LR,-2MHz}$	125 kbps Bluetooth LE LR mode, Adjacent (-2 MHz) interference		-36		dB
$C/I_{125k BLE LR,+2MHz}$	125 kbps Bluetooth LE LR mode, Adjacent (+2 MHz) interference		-52		dB
$C/I_{125k BLE LR,\geq 3MHz}$	125 kbps Bluetooth LE LR mode, Adjacent ( $\geq 3$ MHz) interference		-55		dB
$C/I_{125k BLE LR,image}$	Image frequency interference		-36		dB
$C/I_{IEEE 802.15.4,-5MHz}$	IEEE 802.15.4 mode, Adjacent (-5 MHz) rejection		-35		dB
$C/I_{IEEE 802.15.4,+5MHz}$	IEEE 802.15.4 mode, Adjacent (+5 MHz) rejection		-38		dB
$C/I_{IEEE 802.15.4,\pm 10MHz}$	IEEE 802.15.4 mode, Alternate ( $\pm 10$ MHz) rejection		-50		dB

RX selectivity with equal modulation on interfering signal<sup>7</sup>

<sup>7</sup> Desired signal level at  $P_{IN} = -67$  dBm. One interferer is used, having equal modulation as the desired signal. The input power of the interferer where the sensitivity equals  $BER = 0.1\%$  is presented.

## 5.2.7. RX intermodulation

Symbol	Description	Min.	Typ.	Max.	Units
$P_{IMD,5TH,1M,BLE}$	IMD performance, Bluetooth LE 1 Mbps, 5th offset channel, packet length $\leq 37$ bytes		-19		dBm
$P_{IMD,5TH,2M,BLE}$	IMD performance, Bluetooth LE 2 Mbps, 5th offset channel, packet length $\leq 37$ bytes		-16		dBm

RX intermodulation: Desired signal level at  $P_{IN} = -64$  dBm. Two interferers with equal input power are used.

The interferer closest in frequency is not modulated, the other interferer is modulated equal with the desired signal.

The input power of the interferers where the sensitivity equals  $BER = 1E-3$  is presented.

## 5.2.8. Radio timing parameters

Symbol	Description	Min.	Typ.	Max.	Units
$t_{TXEN,BLE,1M}$	Time between TXEN task and READY event after channel FREQUENCY configured (1 Mbps Bluetooth LE and 150 $\mu$ s TIFS)		140		$\mu$ s
$t_{TXEN,FAST,BLE,1M}$	Time between TXEN task and READY event after channel FREQUENCY configured (1 Mbps Bluetooth LE with fast ramp-up and 150 $\mu$ s TIFS)		40		$\mu$ s
$t_{TXDIS,BLE,1M}$	When in TX, delay between DISABLE task and DISABLED event for MODE = Nrf_1Mbit and MODE = Ble_1Mbit		2		$\mu$ s
$t_{RXEN,BLE,1M}$	Time between the RXEN task and READY event after channel FREQUENCY configured (1 Mbps Bluetooth LE)		134		$\mu$ s
$t_{RXEN,FAST,BLE,1M}$	Time between the RXEN task and READY event after channel FREQUENCY configured (1 Mbps Bluetooth LE with fast ramp-up)		40		$\mu$ s
$t_{RXDIS,BLE,1M}$	When in RX, delay between DISABLE task and DISABLED event for MODE = Nrf_1Mbit and MODE = Ble_1Mbit		1		$\mu$ s
$t_{TXDIS,BLE,2M}$	When in TX, delay between DISABLE task and DISABLED event for MODE = Nrf_2Mbit and MODE = Ble_2Mbit		2		$\mu$ s
$t_{RXDIS,BLE,2M}$	When in RX, delay between DISABLE task and DISABLED event for MODE = Nrf_2Mbit and MODE = Ble_2Mbit		1		$\mu$ s
$t_{TXEN,IEEE802.15.4}$	Time between TXEN task and READY event after channel FREQUENCY configured (IEEE 802.15.4 mode)		130		$\mu$ s
$t_{TXEN,FAST,IEEE802.15.4}$	Time between TXEN task and READY event after channel FREQUENCY configured (IEEE 802.15.4 mode with fast ramp-up)		40		$\mu$ s
$t_{TXDIS,IEEE802.15.4}$	When in TX, delay between DISABLE task and DISABLED event (IEEE 802.15.4 mode)		18		$\mu$ s
$t_{RXEN,IEEE802.15.4}$	Time between the RXEN task and READY event after channel FREQUENCY configured (IEEE 802.15.4 mode)		130		$\mu$ s
$t_{RXEN,FAST,IEEE802.15.4}$	Time between the RXEN task and READY event after channel FREQUENCY configured (IEEE 802.15.4 mode with fast ramp-up)		40		$\mu$ s
$t_{RXDIS,IEEE802.15.4}$	When in RX, delay between DISABLE task and DISABLED event (IEEE 802.15.4 mode)		0.2		$\mu$ s
$t_{RX\text{-to-TX turnaround, IEEE802.15.4}}$	Maximum RX-to-TX turnaround time in IEEE 802.15.4 mode		17		$\mu$ s

## 5.2.9. RSSI specifications

Symbol	Description	Min.	Typ.	Max.	Units
RSSI <sub>ACC</sub>	RSSI accuracy in the range -90 to -30 dBm		±2		dB
RSSI <sub>RESOLUTION</sub>	RSSI resolution		1		dB
RSSI <sub>PERIOD</sub>	RSSI sampling time from RSSI <sub>START</sub> task		0.25		µs
RSSI <sub>SETTLE</sub>	RSSI settling time after signal level change		15	20	µs



## 5.3. GPIO electrical specification

Symbol	Description	Min.	Typ.	Max.	Units
$V_{IH}$	Input high voltage	$0.7 \times V_{DD}$		VDD	V
$V_{IL}$	Input low voltage	VSS		$0.3 \times V_{DD}$	V
$V_{OH,SD}$	Output high voltage, standard drive, 0.5 mA, $V_{DD} \geq 1.7$ V	$V_{DD} - 0.4$		VDD	V
$V_{OH,HDL}$	Output high voltage, high drive, 5 mA, $V_{DD} \geq 2.7$ V	$V_{DD} - 0.4$		VDD	V
$V_{OH,HDL}$	Output high voltage, high drive, 3 mA, $V_{DD} \geq 1.7$ V	$V_{DD} - 0.4$		VDD	V
$V_{OL,SD}$	Output low voltage, standard drive, 0.5 mA, $V_{DD} \geq 1.7$ V	VSS		$V_{SS} + 0.4$	V
$I_{OL,SD}$	Current at $V_{SS} + 0.4$ V, output set low, standard drive, $V_{DD} \geq 1.7$ V	1	3	4	mA
$I_{OL,HDL}$	Current at $V_{SS} + 0.4$ V, output set low, high drive, $V_{DD} \geq 1.7$ V	3			mA
$I_{OL,ED}$	Current at $V_{SS} + 0.4$ V, output set low, extra drive, $V_{DD} \geq 1.7$ V	16			mA
$I_{OH,SD}$	Current at $V_{DD} - 0.4$ V, output set high, standard drive, $V_{DD} \geq 1.7$ V	1	3	4	mA
$I_{OH,HDL}$	Current at $V_{DD} - 0.4$ V, output set high, high drive, $V_{DD} \geq 1.7$ V	4			mA
$I_{OH,ED}$	Current at $V_{DD} - 0.4$ V, output set high, extra drive, $V_{DD} \geq 1.7$ V	14			mA
$I_{GPIO,TOTAL}$	Recommended maximum sustained current drawn by all GPIOs			15	mA
$t_{HR,12pF}$	Rise/Fall time, high drive mode, 20–80%, 12 pF load <sup>1</sup>		4		ns
$t_{ER,12pF}$	Rise/Fall time, extra drive mode, 20–80%, 12 pF load <sup>1</sup>		0.9		ns
$R_{PU}$	Pull-up resistance	12	14	16	k $\Omega$
$R_{PD}$	Pull-down resistance	12	14	18	k $\Omega$
$t_{OE,ED}$	Output enable delay in extra drive mode			855	ns
$C_{PAD}$	Pad capacitance		1		pF
$C_{PAD\_NFC}$	Pad capacitance on NFC pads		5		pF

## 5.4. Absolute maximum ratings

	Parameter	Min.	Max.	Unit
<b>Supply voltage</b>				
VDD	VDD supply voltage	-0.3	3.9	V
VDD <sub>EXT</sub>	VDD supply voltage under extended operating temperature	-0.3	3.7	V
<b>I/O pin voltage</b>				
V <sub>I/O</sub> , VDD ≤ 3.6 V	IO voltage	-0.3	VDD + 0.3	V
V <sub>I/O</sub> , VDD > 3.6 V	IO voltage	-0.3	3.9	V
V <sub>I/O,EXT</sub> , VDD <sub>EXT</sub> ≤ 3.4 V	IO voltage under extended operating temperature	-0.3	VDD + 0.3	V
V <sub>I/O,EXT</sub> , VDD <sub>EXT</sub> > 3.4 V	IO voltage under extended operating temperature	-0.3	3.7	V
<b>Radio</b>				
RF input level			10	dBm
<b>RRAM memory</b>				
Endurance		10,000		Write/ rewrite cycles
Retention at 85°C		10		y
Retention at 105°C		2		y

	Note	Min.	Max.	Unit
<b>Environmental QFN package types</b>				
Storage temperature		-40	+125	°C
Reflow soldering temperature	Reflow cycle time is 30 seconds with 3 maximum reflow cycles.		260	°C
Moisture Sensitivity Level (MSL)			2	
ESD Human Body Model (HBM)			1	kV
ESD Charged Device Model (CDM)			500	V
<b>Environmental CSP package types</b>				
Storage temperature	Recommended storage condition is < 40°C and < 90% RH (relative humidity)	-40	+125	°C
Reflow soldering temperature	Reflow cycle time is 30 seconds with 3 maximum reflow cycles.		260	°C
Moisture Sensitivity Level (MSL)			1	
ESD Human Body Model (HBM)			3	kV
ESD Charged Device Model (CDM)			250	V

# 6. Block diagram

**Model : AN54LV-K15**

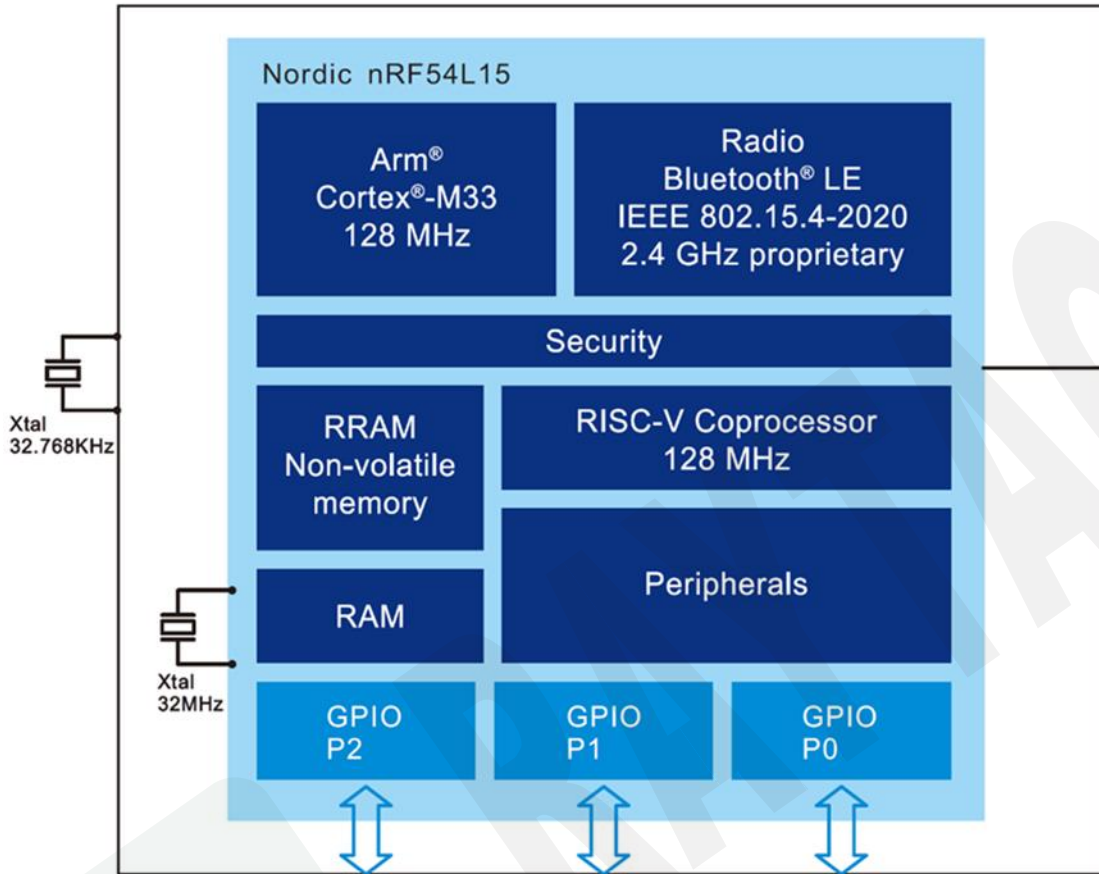

# 7. Reference circuit

Module is pre-programmed with Raytac's testing code. Default is using "DC-DC mode". The Nordic NCS firmware is set to use external 32.768KHz so please add it to make module work.

**REMARK:**

- \*\* DECD decoupling capacitor (2.2μF) is already inside the module. \*\*
- \*\*When enabling the DC/DC regulator, the device checks if an inductor (L1) is connected to the DCC pin. If L1 is not detected, the device remains in LDO mode.\*\*
- \*\* When **NOT** using NFC, please remove NFC1 / C19 / C20. \*\*
- \*\* When using internal 32.768KHz RC oscillator, please remove X2 / C12 / C13. \*\*
- \*\* R39: Place close to the module. \*\*

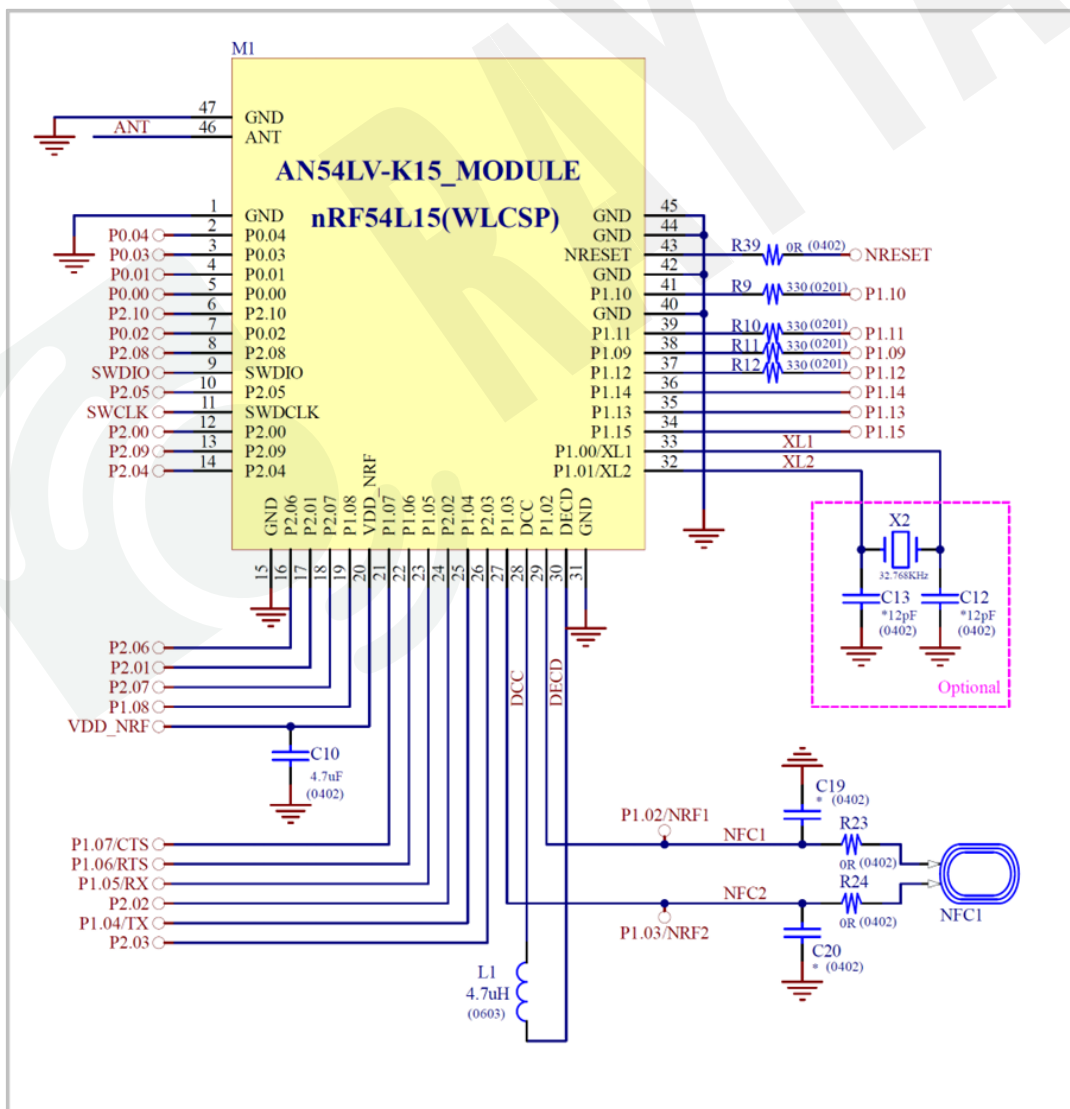

## 8. Certification

### 8.1. Declaration ID for Bluetooth



#### BT 6.0

Declaration ID	QDID(s) and Included DN(s)	Company	Specification Name
Q373526	Q360916 – Controller Subsystem Q361608 – Host Subsystem	Raytac Corporation	6.0

Profile Description	Service Description
Alert Notification Profile	Alert Notification Service
Blood Pressure Profile	Blood Pressure Service
	Device Information Service
Cycling Speed & Cadence Profile	Cycling Speed & Cadence Service
	Device Information Service
Glucose Profile	Glucose Service
	Device Information Service
Health Thermometer Profile	Health Thermometer Service
	Device Information Service
Heart Rate Profile	Heart Rate Service
	Device Information Service
HID over GATT Profile	HID Service
	Battery Service
Proximity Profile	Link Loss Service
	Immediate Alert Service
	TX Power Service
Running Speed & Cadence Profile	Running Speed & Cadence Service
	Device Information Service
Time Profile	Time Profile Service
Glucose Profile (Central)	
Mesh Profile	Mesh Provisioning Service
	Mesh Proxy Service

## 8.2. FCC Certificate (USA)

### 2.4GHz wireless module

			
<b>TCB</b>	<b>GRANT OF EQUIPMENT AUTHORIZATION</b> Certification Issued Under the Authority of the Federal Communications Commission By:		<b>TCB</b>
	Kiwa Nederland B.V. Wilmersdorf 50 Apeldoorn, NL-7300 AC Netherlands		Date of Grant: 12/21/2025  Application Dated: 12/16/2025
<b>Raytac Corp.</b> 8F, No.788-1, Zhongzheng Rd., Zhonghe Dist., New Taipei City., 235 Taiwan			
<b>Attention: Lyon Liu , President</b>			
<b>NOT TRANSFERABLE</b>			
EQUIPMENT AUTHORIZATION is hereby issued to the named GRANTEE, and is VALID ONLY for the equipment identified hereon for use under the Commission's Rules and Regulations listed below.			
<b>FCC IDENTIFIER:</b>	SH6AN54LV		
<b>Name of Grantee:</b>	Raytac Corp.		
<b>Equipment Class:</b>	Digital Transmission System		
<b>Notes:</b>	Bluetooth Low Energy Module		
<b>Modular Type:</b>	Single Modular		
<b>Grant Notes</b>	<b>FCC Rule Parts</b>	<b>Frequency Range (MHZ)</b>	<b>Output Watts</b>
	15C	2402.0 - 2480.0	0.006
Output power listed is conducted. This grant is valid only when the module is sold to OEM integrators and must be installed by the OEM or OEM integrators. The antenna's as listed in this application must be installed to provide a separation distance of at least 20 cm from all persons and must not be co-located or operating in conjunction with any other antenna or transmitter. End-users may not be provided with the module installation instructions. OEM integrators and end-users must be provided with transmitter operating conditions for satisfying RF exposure compliance.			
Certificate No.: 252181982/AA/00	Wim van Loon Managing director Nederland		

## SAR report



Report No.: TESA2509000666ES

Page: 1 of 9

# RF EXPOSURE REPORT



**Applicant:** Raytac Corp.  
8F, No.788-1, Zhongzheng Rd., Zhonghe Dist., New Taipei  
City, 235, Taiwan

**Manufacturer:** Raytac Corp.  
8F, No.788-1, Zhongzheng Rd., Zhonghe Dist., New Taipei  
City, 235, Taiwan

**Product Name:** Bluetooth Low Energy Module

**Brand Name:** Raytac

**Model No.:** AN54LV

**Family Model No.:** AN54LV-P,AN54LV-U,AN54LV-K

**Model Difference:** Please refer to section 1.2 for more details

**FCC ID** SH6AN54LV

**IC:** 8017A-AN54LV

**Date of EUT Received:** Aug. 18, 2025

**Issue Date:** Dec. 05, 2025

Approved By \_\_\_\_\_

*John Teh*

*John Yeh*

### We hereby certify that:

The above equipment was evaluated by SGS Taiwan Ltd. The evaluation in this report is in compliance with FCC Rule Part §2.1091, KDB 447498 D01 v06 and RSS-102 issue 6.

The results of this report relate only to the sample identified in this report.

## VERIFICATION OF COMPLIANCE

**Issue Date:** Dec. 04, 2025  
**Applicant:** Raytac Corp.  
**Address:** 8F, No.788-1, Zhongzheng Rd., Zhonghe Dist., New Taipei City, 235, Taiwan  
**Manufacturer:** Raytac Corp.  
**Address:** 8F, No.788-1, Zhongzheng Rd., Zhonghe Dist., New Taipei City, 235, Taiwan  
**Product:** Bluetooth Low Energy Module  
**Brand Name/Trade Mark:** Raytac  
**Model/Type:** AN54LV  
**Added Model(s):** AN54LV-P, AN54LV-U, AN54LV-K  
**Applicable Standards:** 47 CFR FCC Part 15 Subpart B  
ICES-003 Issue 7 : October 2020  
ANSI C63.4 : 2014  
**Test Laboratory:** SGS Taiwan Ltd.  
Electromagnetic Compatibility Laboratory  
No.2, Keji 1st Rd., Guishan District, Taoyuan City, Taiwan  
**Test Report No.:** TMHY2511002630YE, dated on Dec. 04, 2025

**Conclusion:** Based upon a review of the Test Report(s), the tested sample of the product mentioned above is deemed to comply with the requirements of the above standards.

**Note:** This verification is only valid for the product and configuration described and in conjunction with the test report as detailed above.

**Authorised Signatory:**



SGS Taiwan Ltd.  
Eddy Cheng  
Asst. Supervisor





## 8.3. TELEC Certificate (Japan)

1 Mbps & 2 Mbps

		
	<b>Certificate of Radio Equipment in JAPAN 201-250932 / 00</b>	
	<b>Issued</b> 24 December 2025	
	<b>Page</b> 1 of 5 This certificate has THREE Annexes	
	Kiwa Nederland B.V., operating as Japan Conformity Assessment Body (CAB ID Number: 201), according procedure RD_740, declares that the listed product complies with the Technical Regulations Conformity Certification of Specified Radio equipment (ordinance of MPT N° 37,1981)	
	<b>Product description:</b> Bluetooth Low Energy Module	
	<b>Trademark:</b> Raytac	
	<b>Type designation:</b> AN54LV	
	<b>Hardware / Software:</b> 1 / 1	
	<b>Variants:</b> See Annex 3	
<b>Manufacturer:</b> Raytac Corp.		
<b>Address:</b> 8F., No. 788-1, Zhongzheng Rd., Zhonghe Dist.,		
<b>City:</b> 235 New Taipei City		
<b>Country:</b> Taiwan		
<b>This certificate is granted to:</b>		
<b>Name:</b> Raytac Corp.		
<b>Address:</b> 8F., No. 788-1, Zhongzheng Rd., Zhonghe Dist.,		
<b>City:</b> 235 New Taipei City		
<b>Country:</b> Taiwan		
		
Wim van Loon Managing director Nederland		
Kiwa Nederland B.V. Wilmersdorf 50 Postbus 137 7300 AC Apeldoorn The Netherlands		
<a href="https://www.kiwa.com/nl/en/markets/radio-wireless-and-electrical-equipment/">https://www.kiwa.com/nl/en/markets/ radio-wireless-and-electrical- equipment/</a>		
Chamber of commerce 08090048		
		

## 8.4. NCC Certificate (Taiwan)

### 1 Mbps & 2 Mbps AN54LV

	<b>台灣檢驗科技股份有限公司</b> <b>電信管制射頻器材型式認證證明</b>	
證照字號：型式字第 AM 號		
一、申請者：勁達國際電子股份有限公司		
二、地址：臺北市大安區和平東路1段145號5樓之1		
三、製造廠商：勁達國際電子股份有限公司		
四、器材名稱：藍牙模組		
五、廠牌：Raytac		
六、型號：AN54LV		
七、發射功率(電場強度)：詳細射頻規格如備註欄		
八、工作頻率：詳細射頻規格如備註欄		
九、審驗日期：114年12月16日		
十、審驗合格標籤式樣：		
十一、警語或標示要求：(器材本體、使用手冊、外包裝盒等應遵守下列標示要求)		
1. 應於本體明顯處標示審驗合格標籤或符合性聲明標籤及其型號，並於包裝盒標示主管機關標章。最終產品應於本體明顯處標示非隨插即用射頻模組(組件)之審驗合格標籤及最終產品型號，並於包裝盒標示主管機關標章，始得販賣。		
2. 依主管機關或相關技術規範規定於指定位置標示正體中文警語。		
3. 經授權使用射頻模組(組件)之審驗合格標籤者，應於最終產品說明書及包裝盒提供充分與正確之資訊。		
4. 於網際網路販賣電信管制射頻器材者，應於該網際網路網頁標示其型號及審驗合格標籤或符合性聲明標籤資訊。但最終產品得僅標示其型號及其組裝之非隨插即用射頻模組(組件)之審驗合格標籤資訊。		
5. 使用手冊應標示下列資訊：		
(1) 取得審驗證明之低功率射頻器材，非經核准，公司、商號或使用者均不得擅自變更頻率、加大功率或變更原設計之特性及功能。低功率射頻器材之使用不得影響飛航安全及干擾合法通信；經發現有干擾現象時，應立即停用，並改善至無干擾時方得繼續使用。前述合法通信，指依電信管理法規定作業之無線電通信。低功率射頻器材須忍受合法通信或工業、科學及醫療用電波輻射性電機設備之干擾。		
型式認證號碼：CCAM25Y10270T0	第 1 頁，共 2 頁	本證書與續頁分開使用無效

## AN54LV-P

SGS

台灣檢驗科技股份有限公司  
電信管制射頻器材型式認證證明



證照字號：型式字第 AM 號

- 一、申請者：勁達國際電子股份有限公司
- 二、地址：臺北市大安區和平東路1段145號5樓之1
- 三、製造廠商：勁達國際電子股份有限公司
- 四、器材名稱：藍牙模組
- 五、廠牌：Raytac
- 六、型號：AN54LV-P
- 七、發射功率(電場強度)：詳細射頻規格如備註欄
- 八、工作頻率：詳細射頻規格如備註欄
- 九、審驗日期：114年12月16日

十、審驗合格標籤式樣：

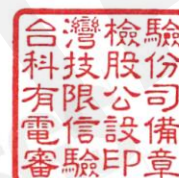

十一、警語或標示要求：(器材本體、使用手冊、外包裝盒等應遵守下列標示要求)

1. 應於本體明顯處標示審驗合格標籤或符合性聲明標籤及其型號，並於包裝盒標示主管機關標章。最終產品應於本體明顯處標示非隨插即用射頻模組(組件)之審驗合格標籤及最終產品型號，並於包裝盒標示主管機關標章，始得販賣。
2. 依主管機關或相關技術規範規定於指定位置標示正體中文警語。
3. 經授权使用射頻模組(組件)之審驗合格標籤者，應於最終產品說明書及包裝盒提供充分與正確之資訊。
4. 於網際網路販賣電信管制射頻器材者，應於該網際網路網頁標示其型號及審驗合格標籤或符合性聲明標籤資訊。但最終產品得僅標示其型號及其組裝之非隨插即用射頻模組(組件)之審驗合格標籤資訊。
5. 使用手冊應標示下列資訊：
  - (1) 取得審驗證明之低功率射頻器材，非經核准，公司、商號或使用者均不得擅自變更頻率、加大功率或變更原設計之特性及功能。低功率射頻器材之使用不得影響飛航安全及干擾合法通信；經發現有干擾現象時，應立即停用，並改善至無干擾時方得繼續使用。前述合法通信，指依電信管理法規定作業之無線電通信。低功率射頻器材須忍受合法通信或工業、科學及醫療用電波輻射性電機設備之干擾。

## AN54LV-U

SGS

台灣檢驗科技股份有限公司  
電信管制射頻器材型式認證證明



證照字號：型式字第 AM 號

- 一、申請者：勁達國際電子股份有限公司
- 二、地址：臺北市大安區和平東路1段145號5樓之1
- 三、製造廠商：勁達國際電子股份有限公司
- 四、器材名稱：藍牙模組
- 五、廠牌：Raytac
- 六、型號：AN54LV-U
- 七、發射功率(電場強度)：詳細射頻規格如備註欄
- 八、工作頻率：詳細射頻規格如備註欄
- 九、審驗日期：114年12月16日

十、審驗合格標籤式樣：



十一、警語或標示要求：(器材本體、使用手冊、外包裝盒等應遵守下列標示要求)

1. 應於本體明顯處標示審驗合格標籤或符合性聲明標籤及其型號，並於包裝盒標示主管機關標章。最終產品應於本體明顯處標示非隨插即用射頻模組(組件)之審驗合格標籤及最終產品型號，並於包裝盒標示主管機關標章，始得販賣。
2. 依主管機關或相關技術規範規定於指定位置標示正體中文警語。
3. 經授權使用射頻模組(組件)之審驗合格標籤者，應於最終產品說明書及包裝盒提供充分與正確之資訊。
4. 於網際網路販賣電信管制射頻器材者，應於該網際網路網頁標示其型號及審驗合格標籤或符合性聲明標籤資訊。但最終產品得僅標示其型號及其組裝之非隨插即用射頻模組(組件)之審驗合格標籤資訊。
5. 使用手冊應標示下列資訊：
  - (1) 取得審驗證明之低功率射頻器材，非經核准，公司、商號或使用者均不得擅自變更頻率、加大功率或變更原設計之特性及功能。低功率射頻器材之使用不得影響飛航安全及干擾合法通信；經發現有干擾現象時，應立即停用，並改善至無干擾時方得繼續使用。前述合法通信，指依電信管理法規定作業之無線電通信。低功率射頻器材須忍受合法通信或工業、科學及醫療用電波輻射性電機設備之干擾。

## AN54LV-K

SGS

台灣檢驗科技股份有限公司  
電信管制射頻器材型式認證證明



證照字號：型式字第 AM 號

- 一、申請者：勁達國際電子股份有限公司
- 二、地址：臺北市大安區和平東路1段145號5樓之1
- 三、製造廠商：勁達國際電子股份有限公司
- 四、器材名稱：藍牙模組
- 五、廠牌：Raytac
- 六、型號：AN54LV-K
- 七、發射功率(電場強度)：詳細射頻規格如備註欄
- 八、工作頻率：詳細射頻規格如備註欄
- 九、審驗日期：114年12月16日

十、審驗合格標籤式樣：



十一、警語或標示要求：(器材本體、使用手冊、外包裝盒等應遵守下列標示要求)

1. 應於本體明顯處標示審驗合格標籤或符合性聲明標籤及其型號，並於包裝盒標示主管機關標章。最終產品應於本體明顯處標示非隨插即用射頻模組(組件)之審驗合格標籤及最終產品型號，並於包裝盒標示主管機關標章，始得販賣。
2. 依主管機關或相關技術規範規定於指定位置標示正體中文警語。
3. 經授权使用射頻模組(組件)之審驗合格標籤者，應於最終產品說明書及包裝盒提供充分與正確之資訊。
4. 於網際網路販賣電信管制射頻器材者，應於該網際網路網頁標示其型號及審驗合格標籤或符合性聲明標籤資訊。但最終產品得僅標示其型號及其組裝之非隨插即用射頻模組(組件)之審驗合格標籤資訊。
5. 使用手冊應標示下列資訊：
  - (1) 取得審驗證明之低功率射頻器材，非經核准，公司、商號或使用者均不得擅自變更頻率、加大功率或變更原設計之特性及功能。低功率射頻器材之使用不得影響飛航安全及干擾合法通信；經發現有干擾現象時，應立即停用，並改善至無干擾時方得繼續使用。前述合法通信，指依電信管理法規定作業之無線電通信。低功率射頻器材須忍受合法通信或工業、科學及醫療用電波輻射性電機設備之干擾。

## 8.5. CE (EU) & RCM (Australia & New Zealand) test report

1 Mbps & 2 Mbps

	Report No.: TERF2509002906E2 Page: 1 of 61
<b>AS/NZS 4268:2017 Amd 1:2021</b> <b>ETSI EN 300 328 v2.2.2: 2019</b> <b>TEST REPORT</b>	 
<b>Applicant:</b>	Raytac Corp. 8F, No.788-1, Zhongzheng Rd., Zhonghe Dist., New Taipei City, 235, Taiwan
<b>Manufacturer:</b>	Raytac Corp. 8F, No.788-1, Zhongzheng Rd., Zhonghe Dist., New Taipei City, 235, Taiwan
<b>Product Name:</b>	Bluetooth Low Energy Module
<b>Brand Name:</b>	Raytac
<b>Model No.:</b>	AN54LV
<b>Family Model No.:</b>	AN54LV-P, AN54LV-U, AN54LV-K
<b>Model Difference:</b>	Please refer to section 1.4 for more details
<b>Report Number:</b>	TERF2509002906E2
<b>Date of EUT Received:</b>	August 18, 2025
<b>Date of Test:</b>	September 15, 2025 ~ November 15, 2025
<b>Issue Date:</b>	December 8, 2025
<b>Approved By</b> _____	 Jay Lin
<b>We hereby certify that:</b>	
The above equipment was tested by SGS Taiwan Ltd., Central RF Lab for compliance with the requirements set forth in the European Standard ETSI EN 300 328 v2.2.2: 2019 under 2014/53/EU and Australian/New Zealand Standard AS/NZS 4268:2017 Amd 1:2021, Row 59. The results of testing in this report apply to the product system that was tested only. Other similar equipment will not necessarily produce the same results due to production tolerance and measurement uncertainties.	

## RF EXPOSURE REPORT



**Applicant:** Raytac Corp.  
8F, No.788-1, Zhongzheng Rd., Zhonghe Dist., New Taipei  
City, 235, Taiwan

**Manufacturer:** Raytac Corp.  
8F, No.788-1, Zhongzheng Rd., Zhonghe Dist., New Taipei  
City, 235, Taiwan

**Product Name:** Bluetooth Low Energy Module

**Brand Name:** Raytac

**Model No.:** AN54LV

**Family Model No.:** AN54LV-P,AN54LV-U,AN54LV-K

**Model Difference:** Please refer to section 1.2 for more details

**Date of EUT Received:** Aug. 18, 2025

**Issue Date:** Dec. 05, 2025

Approved By \_\_\_\_\_

*John Yeh*  
John Yeh

**We hereby certify that:**

The above equipment was evaluated by SGS Taiwan Ltd. for compliance with the requirements set forth in the European Standard EN 62479:2010, EN 50663: 2017 and Australia/New Zealand Standard AS/NZS 2772.2:2016.

The results in this report apply to this specific product system.



Test Report issued under the responsibility of:



<b>TEST REPORT</b> <b>IEC 62368-1</b> <b>Audio/video, information and communication technology equipment</b> <b>Part 1: Safety requirements</b>	
Report Number.....	TSSF2511000660L0
Date of issue .....	2025-11-21
Total number of pages .....	49
Name of Testing Laboratory preparing the Report .....	SGS Taiwan Ltd. Safety Laboratory
Applicant's name .....	Raytac Corp.
Address .....	8F, No.788-1, Zhongzheng Rd., Zhonghe Dist., New Taipei City, 235, Taiwan
<b>Test specification:</b>	
Standard .....	IEC 62368-1:2018
Test procedure .....	Commission testing
Non-standard test method .....	N/A
TRF template used .....	IECEE OD-2020-F1:2021, Ed.1.4
Test Report Form No.....	IEC62368_1E modify by SGS TW (EN)
Test Report Form(s) Originator.....	UL(US)
Master TRF .....	Dated 2023-12
<b>Copyright © 2021 IEC System of Conformity Assessment Schemes for Electrotechnical Equipment and Components (IECEE System). All rights reserved.</b>	
<small>This publication may be reproduced in whole or in part for non-commercial purposes as long as the IECEE is acknowledged as copyright owner and source of the material. IECEE takes no responsibility for and will not assume liability for damages resulting from the reader's interpretation of the reproduced material due to its placement and context.</small>	
<b>General disclaimer:</b>	
The test results presented in this report relate only to the object tested. This report shall not be reproduced, except in full, without the written approval of the Issuing CB Testing Laboratory. The authenticity of this Test Report and its contents can be verified by contacting the NCB, responsible for this Test Report.	

<b>Test item description</b> .....	Bluetooth Low Energy Module	
<b>Trade Mark(s)</b> .....	Raytac	
<b>Manufacturer</b> .....	Same as Applicant	
<b>Model/Type reference</b> .....	AN54LV, AN54LV-P, AN54LV-U, AN54LV-K	
<b>Ratings</b> .....	3.3Vdc	
<b>Responsible Testing Laboratory (as applicable), testing procedure and testing location(s):</b>		
<input type="checkbox"/> <b>Testing Laboratory:</b>	SGS Taiwan Ltd., Safety Laboratory	
<b>Testing location/ address</b> .....	No. 33, Wu Chyuan Road, New Taipei Industrial Park, Wu Ku District, New Taipei City 24886, Taiwan	
<b>Tested by (name, function, signature) .....</b>	Kai Chai Project handler	<i>Kai Chai</i>
<b>Approved by (name, function, signature) ..</b>	Kenny Cheng Reviewer	<i>Kenny Cheng</i>

## VERIFICATION OF COMPLIANCE

**Issue Date:** Dec. 04, 2025  
**Applicant:** Raytac Corp.  
**Address:** 8F, No.788-1, Zhongzheng Rd., Zhonghe Dist., New Taipei City, 235, Taiwan  
**Manufacturer:** Raytac Corp.  
**Address:** 8F, No.788-1, Zhongzheng Rd., Zhonghe Dist., New Taipei City, 235, Taiwan  
**Product:** Bluetooth Low Energy Module  
**Brand Name/Trade Mark:** Raytac  
**Model/Type:** AN54LV  
**Added Model(s):** AN54LV-P, AN54LV-U, AN54LV-K  
**Applicable Standards:** EN 301 489 -1 v2.2.3 : 2019-11  
EN 301 489 -17 v3.3.1 : 2024-09  
EN 55032 : 2015+A11:2020  
EN 61000-4-2 : 2009  
EN IEC 61000-4-3 : 2020  
EN 61000-4-4 : 2012  
EN 61000-4-6 : 2014+AC:2015  
**Test Laboratory:** SGS Taiwan Ltd.  
Electromagnetic Compatibility Laboratory  
No.2, Keji 1st Rd., Guishan District, Taoyuan City, Taiwan  
**Test Report No.:** TMHY2511002628YE, dated on Dec. 04, 2025

**Conclusion:** Based upon a review of the Test Report(s), the tested sample of the product mentioned above is deemed to comply with the requirements of the above standards.

**Note:** This verification is only valid for the product and configuration described and in conjunction with the test report as detailed above.

**Authorised Signatory:**



SGS Taiwan Ltd.  
Eddy Cheng  
Asst. Supervisor

# RCM SDoc

## Supplier's declaration of conformity



This is the Australian Communications and Media Authority (ACMA) approved form for a declaration of conformity under the following legislative instruments:

- > Radiocommunications Equipment (General) Rules 2021
- > Radiocommunications Labelling (Electromagnetic Compatibility) Notice 2017.

This is a sample form for a declaration of conformity under the Telecommunications (Labelling Notice for Customer Equipment and Customer Cabling) Instrument 2025.

### Instructions for completion

**Do not return this form to the ACMA.** This completed form must be retained by the supplier as part of the documentation required for the compliance records. However, it must be made available for inspection by the ACMA when requested.

### Supplier's details (manufacturer, importer or authorised agent)

Company name (or individual)

N121 PTY LTD

ACN/ARBN

646 997 373

Street address (Australia or New Zealand)

UNIT 5, 25-31 ALEXANDRA STREET  
DRUMMOYNE NSW 2047, AUSTRALIA

### Product details and date of manufacture

Product description – brand name, type, current model, lot, batch or serial number (if available), software/firmware version (if applicable)

Equipment name: Bluetooth Low Energy Module
Model name: AN54LV
Variant model name: AN54LV-P, AN54LV-U, AN54LV-K
Brand name: Raytac

### Compliance – applicable standards and other supporting documents

Evidence of compliance with applicable standards may be demonstrated by test reports, endorsed/accredited test reports, certification/competent body statements.

Having had regard to these documents, I am satisfied the above-mentioned product complies with the requirements of the relevant ACMA standards made under the *Radiocommunications Act 1992* and/or the *Telecommunications Act 1997*.

List these documents including details of the standard title, number and, if applicable, number of the test report/endorsed test report or certification/competent body statement.

Standard	Report number
Radiocommunications Labelling (Electromagnetic Compatibility) Notice 2017 (AS/NZS CISPR 32:2015+A1:2020)	TMHY2511002629YE
Radiocommunications Equipment (General) Rules 2021	TERF2509002906E2

### Declaration

I hereby declare that:

1. I am authorised to make this declaration on behalf of the Company mentioned above
2. the contents of this form are true and correct
3. the product mentioned above complies with the applicable above mentioned standards and all products supplied under this declaration will be identical to the product identified above
4. I understand that giving false or misleading information is a serious offence.

**Note:** It is an offence to knowingly provide false or misleading information to a Commonwealth entity or a person who is exercising powers, performing functions under, or in connection with, a law of the Commonwealth. It is an offence to knowingly provide false or misleading information or documents in compliance or purported compliance with a law of the Commonwealth. (See sections 137.1 and 137.2 of the *Criminal Code Act 1995*.)

Penalty: 12 months imprisonment

Signature of Authorised Person	Date	Print Name	Position
	December 22, 2025	Daniel	Managing Director

The *Privacy Act 1988* (Cth) (the Privacy Act) imposes obligations on the ACMA in relation to the collection, security, quality, access, use and disclosure of personal information. These obligations are detailed in the Australian Privacy Principles.

The ACMA may only collect personal information if it is reasonably necessary for, or directly related to, one or more of the ACMA's functions or activities.

The purpose of collecting the personal information in this form is to ensure the supplier is identified in the 'declaration of conformity'. If this declaration of conformity is not completed and the requested information is not provided, a compliance label cannot be applied.

Further information on the Privacy Act and the ACMA's privacy policy is available at [www.acma.gov.au/privacypolicy](http://www.acma.gov.au/privacypolicy). The privacy policy contains details about how you may access personal information about you that is held by the ACMA, and seek the correction of such information. It also explains how you may complain about a breach of the Privacy Act and how we will deal with such a complaint.

Should you have any questions in this regard, please contact the ACMA's privacy contact officer on telephone on 1800 226 667 or by email at [privacy@acma.gov.au](mailto:privacy@acma.gov.au).

**RADIO SPECTRUM  
MANAGEMENT**



**Supplier's Declaration of Conformity**

Section 134 (1) (g) of the New Zealand Radiocommunications Act 1989

**Supplier's Details:**

**Name:** JNM NZ LIMITED

**Supplier Number:** E9659

**New Zealand Company Number:** 8308895

**Address:** 1 Mariner Lane Beachlands2018 New Zealand

**Product Details:**

Brand name (Manufacture name)	<b>Raytac</b>		
Product name (Description)	<b>Bluetooth Low Energy Module</b>	Model name	<b>AN54LV</b>
		Variant model	<b>AN54LV-P,AN54LV-U,AN54LV-K</b>
Frequency	<b>2 402 MHz ~ 2 480 MHz</b>	Radiated power e.i.r.p (dBm):	<b>9.97 dBm</b>
Applicable Standards Title, Number and Edition	<b>AS/NZS CISPR 32:2015+A1:2020 AS/NZS 4268:2017:AMD1:2021 ETSI EN 300 328 V 2.2.2</b>		
Test Report Numbers	<b>TMHY2511002629YE TERF2509002906E2</b>		

I hereby declare that the product to which this Declaration of conformity relates complies with the above-mentioned standard(s), and all products supplied under this Declaration will be identical to the sample identified in this Declaration.

Daniel  
Director  
22 December 2025

## 8.6. IC Certificate (Canada)

### 2.4GHz wireless module



**CB** TECHNICAL ACCEPTANCE CERTIFICATE  
CERTIFICAT D'APPROBATION TECHNIQUE

▶ Reg. No. NL0001

CERTIFICATION No. 8017A-AN54LV  
No. DE CERTIFICATION

**Issued** 22 December 2025

**Page** 1 of 2  
This certificate has ONE Annex

KIWA No. 252170726/AA/00  
No. DE KIWA

TEST SITE No. 4620E  
No. DE LABORATOIRE

ISSUED TO 8F, No.788-1, Zhongzheng Rd., Zhonghe Dist. New  
DÉLIVRÉ A Taipei City 235 Taiwan

TYPE OF EQUIPMENT Bluetooth device  
GENRE DE MATÉRIEL

TRADE NAME Raytac  
MARQUE

MODEL (HVIN) AN54LV, AN54LV-P, AN54LV-U, AN54LV-K  
MODELE (HVIN)

FVIN 1

PMN AN54LV, AN54LV-P, AN54LV-U, AN54LV-K

CERTIFIED TO	SPECIFICATION	RSS-102	ISSUE	6
CERTIFIÉ SELON LE	CAHIER DES CHARGES	RSS-247	EDITION	4

ISSUED BY KIWA NEDERLAND B.V. (NL0001), RECOGNIZED CERTIFICATION BODY BY INNOVATION, SCIENCE AND ECONOMIC DEVELOPMENT CANADA, ACCORDING THE CANADIAN CERTIFICATION BODY SCHEME (REC-CB).  
DÉLIVRÉ PAR KIWA NEDERLAND B.V. (NL0001), ORGANISME DE CERTIFICATION RECONNU PAR INNOVATION, SCIENCES ET DÉVELOPPEMENT ÉCONOMIQUE CANADA, SELON LE SYSTÈME D'ORGANISME DE CERTIFICATION DE CANADA (REC-CB).

I hereby attest that the subject equipment was tested and found to be in compliance with the noted specification.  
J'atteste, par la présente, que le matériel a fait l'objet d'essai et a été jugé conforme à la spécification indiquée.

Kiwa Nederland B.V.  
Wilmersdorf 50  
Postbus 137  
7300 AC Apeldoorn  
The Netherlands

<https://www.kiwa.com/nl/en/markets/radio-wireless-and-electrical-equipment/>

Chamber of commerce  
08090048

George Lo  
Reviewer

Danny Sung  
Decision maker



## 8.7. SRRC Certificate (China)

编号：2025-27797

Certificate No.

### 无线电发射设备型号核准证

Radio Transmission Equipment Type Approval Certificate

劲达国际电子股份有限公司（台湾）：

根据《中华人民共和国无线电管理条例》，经审查，下列设备准予颁发无线电发射设备型号核准证。

In accordance with the Radio Regulations of the People's Republic of China, after examination, the Radio Transmission Equipment Type Approval Certificate is granted to the following equipment.

设备名称： 蓝牙模块

Equipment Name

设备型号： AN54LV

Equipment Type

核准代码： 25J71R80V541

CMIIT ID

主要功能： 数据传输

Main Functions

有效期： 五年

Validity

其他事项载于附页。

Additional Items as Seen in Attachments.



Sealed by Issuing Authority

2025年12月32日

Year Month Date

中华人民共和国工业和信息化部统一制作

Issued by the Ministry of Industry and Information Technology of the People's Republic of China

编号: 2025-27869

Certificate No.

## 无线电发射设备型号核准证

Radio Transmission Equipment Type Approval Certificate

劲达国际电子股份有限公司 (台湾):

根据《中华人民共和国无线电管理条例》, 经审查, 下列设备准予颁发无线电发射设备型号核准证。

In accordance with the Radio Regulations of the People's Republic of China, after examination, the Radio Transmission Equipment Type Approval Certificate is granted to the following equipment.

设备名称: 蓝牙模块

Equipment Name

设备型号: AN54LV-U

Equipment Type

核准代码: 25J71R80V542 (M)

CMIIT ID

主要功能: 数据传输

Main Functions

有效期: 五年

Validity

其他事项载于附页。

Additional Items as Seen in Attachments.



中华人民共和国工业和信息化部统一制作

Issued by the Ministry of Industry and Information Technology of the People's Republic of China

## 8.8. KC Certificate (South Korea)

### 2.4GHz wireless module

DA24-23EF-F61D-F520

<b>방송통신기자재등의 적합등록증</b> <i>Registration of Broadcasting and Communication Equipments</i>	
상호 또는 성명 Trade Name or Registrant	Raytac Corporation
기자재명칭(제품명칭) Equipment Name	Bluetooth Low Energy Module
기기부호/추가 기기부호 Equipment code /Additional Equipment code	LARN8
기본모델명 Basic Model Number	AN54LV-U
파생모델명 Series Model Number	AN54LV, AN54LV-K, AN54LV-P
등록번호 Registration No.	R-R-ryt-AN54LV
제조사/제조국가 Manufacturer/Country of Origin	Raytac Corporation/대만
등록연월일 Date of Registration	2026-01-26
기타 Others	
<p>위 기자재는 「전파법」 제58조의2 제3항에 따라 등록되었음을 증명합니다.                      It is verified that foregoing equipment has been registered under the Clause 3, Article 58-2 of Radio Waves Act.</p> <p style="text-align: right;">2026년(Year) 01월(Month) 26일(Day)</p> <p style="text-align: center;">국립전파연구원장 </p> <p style="text-align: center;">Director General of National Radio Research Agency</p> <p style="text-align: center; color: red;">※ 적합등록 방송통신기자재는 반드시 "적합성평가표시" 를 부착하여 유통하여야 합니다.                      위반시 과태료 처분 및 등록이 취소될 수 있습니다.</p>	

## 8.9. EU and UKCA Declarations of Conformity

The product complies with the applicable requirements of both the European Union and United Kingdom regulations, including the essential requirements of the following directives:

- **Radio Equipment Directive: 2014/53/EU**
- **RoHS Directive: 2011/65/EU Annex II and its amendment Directive (EU) 2015/863**

Conformity is demonstrated with reference to the following harmonized standards, based on test reports issued by SGS Taiwan Ltd.:

- **EN 300 328 V2.2.2:2019**
- **EN 301 489-1 V2.2.3 : 2019-11**
- **EN 301 489-17 V3.3.1 : 2024-09**
- **EN 55032 : 2015+A11:2020**
- **EN 61000-4-2 : 2009**
- **EN IEC 61000-4-3 : 2020**
- **EN 61000-4-4 : 2012**
- **EN 61000-4-6 : 2014+AC:2015**
- **IEC 62368-1 : 2018**
- **BS EN IEC 62368-1 : 2020+A11:2020**

RoHS compliance reports were issued by TÜV Rheinland Hong Kong Ltd., covering Directive 2011/65/EU and its amendment Directive (EU) 2015/863.

## 8.10. RoHS & REACH report

Please visit "[Support](#)" page of our website to download.

## 8.11. End-product label

It is suggested using following content adding to package or user manual or label to obey the regulation. Any rules of end-product label shall refer to each regulation for final reference.

### 8.11.1. FCC (USA)

The FCC statement should be included in the user manual when there is no enough space on label. Otherwise, it should be included on the label.

“This device complies with part 15 of the FCC rules. Operation is subject to the following two conditions. (1) This device may not cause harmful interference. (2) This device must accept any interference received, including interference that may cause undesired operation.”

The final end product must be labeled in a visible area with the following: **“Contain FCC ID: SH6AN54LV”**.

### 8.11.2. TELEC (Japan)

When manufacturer is placing the product on the Japanese market, the product must be affixed with the following Specified Radio Equipment marking:



### 8.11.3. NCC (Taiwan)

根據 NCC LP0002 低功率射頻器材技術規範\_章節 3.8.2：

- 取得審驗證明之低功率射頻器材，非經核准，公司、商號或使用者均不得擅自變更模組之頻率、加大功率或更改原設計之特性與功能。
- 低功率射頻器材之使用不得影響飛航安全及干擾合法通信；經發現有干擾現象時，應立即停用，並改善至無干擾時方得繼續使用。
- 低功率射頻器材須忍受合法通信或工業、科學及醫療用電波輻射性電機設備之干擾。

前述合法通信，係指依《電信管理法》規定作業之無線電通信。

此模組於取得認證後，將依規定於模組本體標示審驗合格標籤，並要求平台廠商於平台上標示。

請依下列標籤式樣自製標籤，標貼或印鑄於器材本體明顯處，始得販賣或公開陳列。

Series	標籤樣式
AN54LV Series	
AN54LV-P Series	
AN54LV-U Series	
AN54LV-K Series	

以 AN54LV-15 為例，平台廠商必須於平台上標示字樣「本產品內含射頻模組：ID 編號 CCAM25Y10270T0」。

「平台」定義如下：若器材組裝本案模組，消費者仍能正常使用該器材主要功能，該器材得視為平台。若器材不組裝本案模組，消費者不能正常使用該器材主要功能，該器材不能視為平台。

該類不同廠牌型號器材組裝本案審驗模組後，須分別申請型式認證。

#### 8.11.4. IC (Canada)

The IC statement should be included in the user manual when there is no enough space on label. Otherwise, it should be included on the label.

You are cautioned that changes or modifications not expressly approved by the party responsible for compliance could void the user's authority to operate the equipment.

This device contains licence-exempt transmitter(s)/receiver(s) that comply with Innovation, Science and Economic Development Canada's licence-exempt RSS(s). Operation is subject to the following two conditions:

1. This device may not cause interference, and
2. This device must accept any interference, including interference that may cause undesired operation of the device.

L'émetteur/récepteur exempt de licence contenu dans le présent appareil est conforme aux CNR d'Innovation, Sciences et Développement économique Canada applicables aux appareils radio exempts de licence. L'exploitation est autorisée aux deux conditions

suivantes :

1. l'appareil ne doit pas produire de brouillage, et
2. l'utilisateur de l'appareil doit accepter tout brouillage radioelectrique subi, meme si le brouillage est susceptible d'en compromettre le fonctionnement.

The final end product must be labeled in a visible area with the following: **“Contain IC ID: 8017A-AN54LV”**.

## 8.12. Compliance and Certification

### 8.12.1. List of Applicable FCC Rules

This module has been tested and found to comply with the following requirements for Modular Approval.

- 47 CFR Part 15 Subpart C Intentional Radiators.

### 8.12.2. RF Exposure Considerations

This module has been evaluated for portable RF exposure conditions and is compliant with FCC RF exposure requirements when used in portable configurations. The module is approved for use without a minimum separation distance from the user's body.

Host product manufacturers integrating this module must ensure that their final host product maintains the portable use conditions as tested and documented in the RF exposure compliance reports referenced in the RF exposure exhibit.

Configuration with multiple transmitters in the same host, routine evaluation or SAR testing for the simultaneous transmission of the co-located transmitters according to KDB 447498 is required. The portable host product shall be evaluated for ensuring to continue compliance FCC rule part 2.1093 & part 1.1310 by C2PC. The additional guidance for the portable host products is provided in KDB Publication 996369 D02 and D04.

For the host product is not installed according to this guide, the module certification will be invalid, and a new grant certification will be required for the host product.

End-user documentation shall include the RF exposure information provided below.

### RF Exposure Statement:

This equipment complies with FCC radiation exposure limits set forth for an uncontrolled environment. This transmitter must not be co-located or operating in conjunction with any other antenna or transmitter. The device has been evaluated for portable operation without separation distance from the user and meets the FCC RF exposure requirements for such use.

## 8.12.3. Antennas

This radio transmitter has been approved by Federal Communications Commission and Innovation, Science and Economic Development Canada to operate with the antenna types listed below, with the maximum permissible gain indicated. Antenna types not included in this list that have a gain greater than the maximum gain indicated for any type listed are strictly prohibited for use with this device.

Cet émetteur radio a été approuvé par la Commission fédérale des communications et Innovation, Sciences et Développement économique Canada pour fonctionner avec les types d'antennes énumérés ci-dessous, avec le gain maximal autorisé indiqué. Les types d'antennes non mentionnés dans cette liste dont le gain est supérieur au gain maximal indiqué pour l'un des types énumérés sont strictement interdits avec cet appareil.

### On board antenna

Antenna Type	Supplier	Antenna Part No.	Freq. (MHz)	Peak Antenna Gain (dBi)
PIFA	Raytac	AN54LV	2400~2500	0.57
Dipole	Raytac	AN54LV-P	2400~2500	0.8

### External antenna

Antenna Type	Supplier	Antenna Part No.	Freq. (MHz)	Peak Antenna Gain (dBi)
Dipole	molex	2042811100	2400~2500	2
Dipole	KYOCERA	1001932PT-AC10L0100	2400~2485	2.03
Dipole	Raytac	AN54LV-K	2400~2500	2.11

## 8.12.4. Information on Test Modes and Additional Testing Requirements

The module can be configured to continuously transmit on a specific frequency with a fixed modulation pattern. This allows evaluation of radiated emissions and spurious emissions in a controlled condition.

These test modes are intended for compliance testing only and must not be enabled during normal operation of the final product.

For more detailed information, please contact the grantee for assistance with test modes needed for module/host compliance test requirements.

## 8.12.5. Additional Testing, Part 15 Subpart B Disclaimer

The modular transmitter is only FCC authorized for the specific rule parts (i.e., FCC transmitter rules) listed on the grant, and that the host product manufacturer is responsible for compliance to any other FCC rules that apply to the host not covered by the modular transmitter grant of certification.

The final host product still requires Part 15 Subpart B compliance testing with the modular transmitter installed.

## 8.12.6. Note EMI Considerations

Note that a host manufacturer is recommended to use KDB996369 D04 Module Integration Guide recommending as "best practice" RF design engineering testing and evaluation in case non-linear interactions generate additional non-compliant limits due to module placement to host components or properties.

For standalone mode, reference the guidance in KDB996369 D04 Module Integration Guide and for simultaneous mode; see KDB996369 D02 Module Q&A Question 12, which permits the host manufacturer to confirm compliance.

## 8.13. How to Make Changes

You are cautioned that changes or modifications not expressly approved by the party responsible for compliance could void the user's authority to operate the equipment.

Only Grantees are permitted to make permissive changes, if the module will be used differently than granted conditions, please contact us to ensure modifications will not affect compliance.



## 9. Notes and Cautions

To ensure proper integration and long-term reliability of this RF module, the following regulatory and technical considerations must be observed:

The OEM integrator must not provide instructions to the end user regarding how to install or remove this RF module in the user manual of the final product that integrates this module.

The end user manual shall include all required regulatory information and warnings as shown in the official user manual.

This module is not designed for lifetime use. Like general electronic products, it may degrade after continuous usage over the years. To ensure optimal performance and longevity, please observe the following precautions:

- Follow the guidelines of this document while designing circuit/end-product. Any discrepancy of core Bluetooth technology and technical specification of IC should refer to definition of Bluetooth Organization and Nordic Semiconductor as final reference.
- Do not supply voltage that is not within range of specification.
- Eliminate static electricity at any cost when working with the module as it may cause damage. It is highly recommended adding anti-ESD components to circuit design to prevent damage from real-life ESD events. Anti-ESD methods can be also applied in mechanical design.
- Do not expose modules under direct sunlight for long duration. Modules should be kept away from humid and salty air conditions, and any corrosive gasses or substances. Store it within  $-40^{\circ}\text{C}$  to  $+125^{\circ}\text{C}$  before and after installation.
- Avoid any physical shock, intense stress to the module or its surface.
- Do not wash the module. No-Clean Paste is used in production. Washing it will oxidize the metal shield and have chemistry reaction with No-Clean Paste. Functions of the module are not guaranteed if it has been washed.

The module is not suitable for life support device or system and not allowed to be used in destructive device or systems in any direct or indirect ways. The customer agrees to indemnify Raytac for any losses when applying modules in applications such as the ones described above.

## 10. Useful links

- **Nordic Infocenter:** <https://docs.nordicsemi.com/>  
All the necessary technical files and software development kits of Nordic's chip are on this website.
- **Nordic DevZone:** <https://devzone.nordicsemi.com/questions/>  
A highly recommended website for firmware developer. Interact with other developers and Nordic's employees will help with your questions. The site also includes tutorials in detail to help you get started.
- **Official page of nRF54L15 :** <https://www.nordicsemi.com/Products/nRF54L15>  
A brief introduction to nRF54L15 and download links for Nordic's developing software and SoftDevices.

# Full list of Raytac's WiFi modules

## ● AN7002Q series (QFN package IC)

Series	Nordic Solution	Raytac No.	IC Ver.	Antenna	Size	Weight
AN7002Q	nRF7002	AN7002Q	1	Chip Antenna	17.1 x 10.8 x 2.1 mm	0.78 (±0.02g)
		AN7002Q-P	1	PCB Antenna	17.1 x 10.8 x 2.1 mm	0.79 (±0.02g)
		AN7002Q-U	1	u.FL Connector	16.4 x 10.8 x 2.1 mm	0.85 (±0.02g)

# Full list of Raytac's Bluetooth modules

## ● AN54LQ series (QFN package IC)

Series	Nordic Solution	Raytac No.	IC Ver.	Antenna	RAM	NVM
AN54LQ	nRF54L15	AN54LQ-15	1	Chip Antenna	256 kB	1524 KB
	nRF54L10	AN54LQ-10	1		192 kB	1012 KB
	nRF54L05	AN54LQ-05	1		96 kB	500 KB
AN54LQ-P	nRF54L15	AN54LQ-P15	1	PCB Antenna	256 kB	1524 KB
	nRF54L10	AN54LQ-P10	1		192 kB	1012 KB
	nRF54L05	AN54LQ-P05	1		96 kB	500 KB
AN54LQ-U	nRF54L15	AN54LQ-U15	1	u.FL Connector	256 kB	1524 KB
	nRF54L10	AN54LQ-U10	1		192 kB	1012 KB
	nRF54L05	AN54LQ-U05	1		96 kB	500 KB

## ● AN54LV series (WLCSP package IC)

Series	Nordic Solution	Raytac No.	IC Ver.	Antenna	RAM	NVM
AN54LV	nRF54L15	AN54LV-15	1	Chip Antenna	256 kB	1524 KB
AN54LV-P		AN54LV-P15	1	PCB Antenna		
AN54LV-U		AN54LV-U15	1	u.FL Connector		
AN54LV-K		AN54LV-K15	1	Pin Antenna		

● **MDBT53 series (WLCSP package IC)**

Series	Nordic Solution	Raytac No.	IC Ver.	Antenna	RAM	Flash Memory
MDBT53	nRF5340	MDBT53-1M	1	Chip Antenna	512 kB	1 MB
MDBT53-P	nRF5340	MDBT53-P1M	1	PCB Antenna	512 kB	1 MB
MDBT53-U	nRF5340	MDBT53-U1M	1	u.FL Connector	512 kB	1 MB

● **MDBT53V series (WLCSP package IC)**

Series	Nordic Solution	Raytac No.	IC Ver.	Antenna	RAM	Flash Memory
MDBT53V	nRF5340	MDBT53V-1M	1	Chip Antenna	512 kB	1 MB
MDBT53V-P	nRF5340	MDBT53V-P1M	1	PCB Antenna	512 kB	1 MB

## ● MDBT50 series (QFN package IC)

Series	Nordic Solution	Raytac No.	IC Ver.	Antenna	RAM	Flash Memory
MDBT50	nRF52820	MDBT50-256R	1	Chip Antenna	32 kB	256 kB
	nRF52833	MDBT50-512K	1		128 kB	512 kB
MDBT50-P	nRF52820	MDBT50-P256R	1	PCB Antenna	32 kB	256 kB
	nRF52833	MDBT50-P512K	1		128 kB	512 kB

## ● MDBT50Q series (aQFN package IC)

Series	Nordic Solution	Raytac No.	IC Ver.	Antenna	RAM	Flash Memory
MDBT50Q	nRF52840	MDBT50Q-1MEN	3	Chip Antenna	256 kB	1 MB
	nRF52840	MDBT50Q-1MV2	2			
	nRF52833	MDBT50Q-512K	1		128 kB	512 kB
MDBT50Q-P	nRF52840	MDBT50Q-P1MEN	3	PCB Antenna	256 kB	1 MB
	nRF52840	MDBT50Q-P1MV2	2			
	nRF52833	MDBT50Q-P512K	1		128 kB	512 kB
MDBT50Q-U	nRF52840	MDBT50Q-U1MEN	3	u.FL Connector	256 kB	1 MB
	nRF52840	MDBT50Q-U1MV2	2			
	nRF52833	MDBT50Q-U512K	1		128 kB	512 kB
Dongle	nRF52840	MDBT50Q-RX	1, 2	PCB Antenna	256 kB	1 MB
		MDBT50Q-CX-40	1			
	nRF52833	MDBT50Q-CX-33	1		128 kB	512 kB

● **MDBT42T series (WLCSP package IC)**

Series	Nordic Solution	Raytac No.	IC Ver.	Antenna	RAM	Flash Memory
MDBT42T	nRF52805	MDBT42T-192K	1	Chip Antenna	24 kB	192 kB
MDBT42T-P		MDBT42T-P192K		PCB Antenna		

● **MDBT42TV series (WLCSP package IC)**

Series	Nordic Solution	Raytac No.	IC Ver.	Antenna	RAM	Flash Memory
MDBT42TV	nRF52805	MDBT42TV-192K	1	Chip Antenna	24 kB	192 kB
MDBT42TV-P		MDBT42TV-P192K		PCB Antenna		

● **MDBT42 series (WLCSP package IC)**

Series	Nordic Solution	Raytac No.	IC Ver.	Antenna	RAM	Flash Memory
MDBT42	nRF52832	MDBT42-512KV2	2	Chip Antenna	64 kB	512 kB
MDBT42-P		MDBT42-P512KV2		PCB Antenna		

● **MDBT42V series (WLCSP package IC)**

Series	Nordic Solution	Raytac No.	IC Ver.	Antenna	RAM	Flash Memory
MDBT42V	nRF52832	MDBT42V-512KV2	2	Chip Antenna	64 kB	512 kB
MDBT42V-P		MDBT42V-P512KV2		PCB Antenna		

## ● MDBT42Q series (QFN package IC)

Series	Nordic Solution	Raytac No.	IC Ver.	Antenna	RAM	Flash Memory
MDBT42Q	nRF52832	MDBT42Q-512KEN	3	Chip Antenna	64 kB	512 kB
	nRF52832	MDBT42Q-512KV2	2			
	nRF52810	MDBT42Q-192KV2	2		24 kB	192 kB
	nRF52811	MDBT42Q-192KL	1			
MDBT42Q-P	nRF52832	MDBT42Q-P512KEN	3	PCB Antenna	64 kB	512 kB
	nRF52832	MDBT42Q-P512KV2	2			
	nRF52810	MDBT42Q-P192KV2	2		24 kB	192 kB
	nRF52811	MDBT42Q-P192KL	1			
MDBT42Q-U	nRF52832	MDBT42Q-U512KEN	3	u.FL Connector	64 kB	512 kB
	nRF52832	MDBT42Q-U512KV2	2			

## ● MDBT40 series

Series	Nordic Solution	Raytac No.	IC Ver.	Antenna	RAM	Flash Memory
MDBT40	nRF51822	MDBT40-256V3	3	Chip Antenna	16 kB	256 kB
		MDBT40-256RV3			32 kB	256 kB
MDBT40-P	nRF51822	MDBT40-P256V3	3	PCB Antenna	16 kB	256 kB
		MDBT40-P256RV3			32 kB	256 kB

# Release Note

- 2026/02/25 Version 1.0: 1st Release.

